

# HARDWOOD TECHNICAL SPECIFICATIONS



# HARDWOOD SPECIFICATIONS CONTENTS

To go to required section click coloured headings below

## Section 1

Introduction	3
Specifications	4
Colours	5

## Section 2

<b>Installation Styles</b>	6
Full Height	
Cafe Style	
Tier on Tier	
Tracked Shutters	
Unsupported Shutters	

## Section 3

<b>Framing Styles</b>	7
Beaded	8
Bullnose L	
Insert L	
Plain L	
Tiara Z	9
Crown Z	
Beaded Z	
Bullnose Z	10
Ridge Deco	
Camber Deco	
Insert Hang Strip	
Cover Strip	
T Posts	11
L/Z	
Deco	
Corner Posts	
L/Z	
Deco	
Bay Posts	12
L/Z	
Deco	
Battens	12

## Section 4

<b>Panel details</b>	13
Stile	
Rails	14
Louvres	15
Louvre pin	
Tilt Rods	
Standard tilt rod	
Silent tilt rod	
Offset tilt rod	16
Offset tilt rod for Multi-fold Shutters	

## Section 6

Hardware	17
Bolts & Ring Pulls	19
Panel Configurations	22

## Section 7

<b>Sizing &amp; Measuring</b>	26
Order Size Definition	
Overall Panel size (OP)	
Overall Dimension of frame (OD)	
Tolerances	27
Mounting Type	

## Section 8

Contact Info	28
--------------	----

# 1. HARDWOOD INTRODUCTION

[BACK TO TOP](#)

The Hardwood range combines a MDF frame with Hardwood shutter panels. The main features of the range are that it combines a robust MDF frame with the lightness of Hardwood panels.

**Aesthetics:**

The shutters panels are manufactured in a mix of Hardwoods all with a linear grain ideal for painted shutters giving a flat and uniform finish.

**Frames and Panels:**

Large range of frames available.

**Stiles:**

Please note the stiles are manufactured in a flat or beaded stile. The engineered stiles are reinforced by using multiple layers of wood bonded together ensuring that the panel does not twist or warp.

**Louvres:**

Hardwood is available in 47mm, 63mm, 76mm, 89mm, elliptical louvres.

**Special Shapes:**

No special shapes are available.

**Colour palette:**

There are a total of 23 colours available. Including custom colour (surcharge).



# HARDWOOD SPECIFICATIONS

[BACK TO TOP](#)

## PANEL SIZE LIMITATIONS

Louvre Size	Width				Height		
		Maximum			Minimum	Maximum	Mid rail  Required if
		Single hung	Bi-fold hinged shutter/ Multi-fold with Top and Bottom track	Multi-fold hinged shutters & multi-fold with Top track only			
47mm	152mm	750mm	660mm	550mm (No. of panels ≤ 4)	250mm	3000mm	H>1981mm
63mm	152mm	890mm			250mm	3000mm	H>1981mm
76mm	152mm	890mm			250mm	3000mm	H>1981mm
89mm	152mm	890mm			250mm	3000mm	H>1981mm

## SPECIFICATIONS

Material	Frame MDF, Panel HardWood
Panel Weight per sqm	7.31-7.88 kg
Paint Colours	23
Stain Colours	✗
Custom Colours available	✓
Louvre sizes	47mm 63mm 76mm 89mm
Max single panel width	750mm : 47mm 890mm : 63mm 890mm : 76mm 890mm : 89mm
Max multi panels width	550mm : REST
Max number of panels hinged together	4 (1 if a doorway)
Max and min panel heights	3000mm 250mm
Solid Panels available	✗
Special shapes	✗
Custom Bay Post angles	✓
Stile Type	Plain or Rebate
Fixed Louvres	✓

# HARDWOOD COLOURS

[BACK TO TOP](#)

## COLOURS

Please note. Colours may vary slightly between dye lots. Shutters for the same installation should be ordered together to avoid variations in colour. Colours may vary slightly from colour samples. For this reason, colour samples should be updated annually.

When adding to an existing installation please note on the order card to either use existing dye lot or if you prefer an exact match then you will need to supply a sample from the existing installation and note the order card to this effect. Please note this will be charged as a custom colour.

## COLOUR OPTIONS

HARDWOOD PAINT OPTIONS (23 COLOURS)				
Colour ID	Colour Name		Default Hinge Colour	Optional Hinge Colour
001	Pure White		Pure White	1. Pure White 2. White 3. Pearl 4. Bisque 5. Antique-Brass 6. Bright-Brass 7. Stainless Steel 8. Black 9. Nickel-Plated 10. Brushed Nickel-Plated 11. Crisp Linen 12. String 13. Sea Mist 14. Stone Grey 15. Brown Grey 16. Taupe Grey
002	Extra White		White	
003	Silk White			
004	Bright White			
006	Pearl		Pearl	
007	Ivory Lace		Bisque	
009	Creamy		Pearl	
011	Cameo		Bisque	
012	Crisp Linen		Crisp Linen	
013	Bisque		Bisque	
014	Alabaster			
016	Butter		Crisp Linen	
019	String		String	
030	Moondust		Sea Mist	
032	Sea Mist			
048	Chai		Nickel Plated	
049	Stone Grey		Stone Grey	
051	Brown Grey		Brown Grey	
053	Clay		Nickel Plated	
066	Winchester White		Pearl	
072	Mattingley 267		Sea Mist	
080	Taupe Grey		Taupe Grey	
836	Classic Black (surcharge)		Black	

Due to the nature of material manufacturing, colours may vary slightly between dye lots. Please order shutters for the same home at the same time. Slight variations may also occur between the finished products and the colour swatches you use.

## 2. INSTALLATION STYLES

BACK TO TOP



### FULL HEIGHT

Shutter covering the full height of aperture.



### TRACKED SHUTTERS

#### Bi-Fold

Shutters suspended from a top track hinged together in a bi-fold configuration to allow them to be folded back to the end of the track at 90° or 180°. Suitable for use with patio doors, wardrobes or as a room divider. May be specified and fitted with or without side frames.

#### By-Pass

Shutters suspended from a top track. Panels slide behind or in front of one another to open or close. Suitable for use with patio doors, room dividers and wardrobes. May be specified and fitted with or without side frames.

\* Refer to the separate track specifications for further details.



### CAFE STYLE

Shutter covering only the lower portion of aperture providing privacy and light control but leaving the top portion un-shuttered to maximise light, where privacy is not required.



### SHUTTERS USED AS DOORS

In situations where shutters will be used for a door application, the customer must inform S:CRAFT when placing the order.



### ROOF SHUTTERS

Would not be supplied or covered under warranty.

Please refer to Fiji specifications for roof details.

#### Panel Configuration

L, R, LR	LL, RR, LLRR
	Only available with a tracked installation.
Manufactured with warranty waived	Not covered by warranty.



### TIER ON TIER

Shutter is split into two halves so the top and bottom panels can be independently operated / opened fully. The standard gap between top tier and bottom tier is 2.5mm. For multi-fold tier on tier shutters only 3 or less multi-fold panels are within warranty.

Please note:

1. The factory will add extra hinges to support the panels
2. The factory will add a larger and stronger top and bottom rail. This will reduce the risk of panels sagging.

N.B Customers will be responsible for any EDR re-order where there has been a failure to notify S:CRAFT that the original shutter order was for a door application.

\*We only offer triple-fold panel configuration (e.g. LLL/RRR) Tier on Tier Shutter.  
If a four-fold panel configuration (e.g. LLLL/RRRR) tier on tier is requested then the warranty will be waived automatically.

# FRAMING STYLES

## BEADED

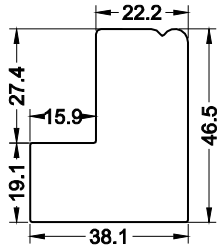

46mm

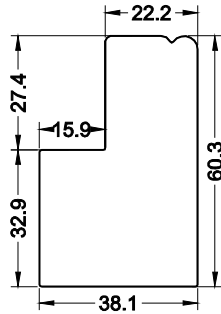

60mm

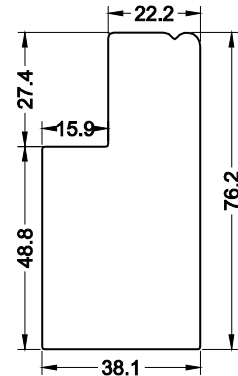

76mm

## INSERT L

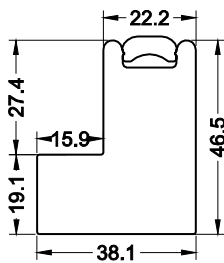

46mm

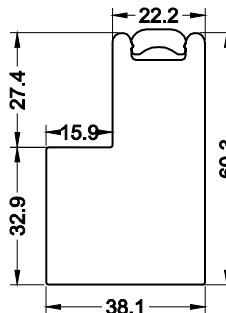

60mm

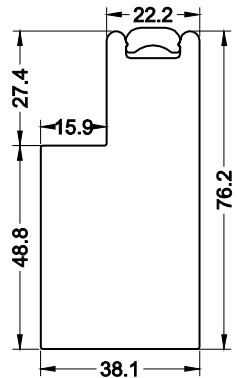

76mm

## DEEP L PLAIN

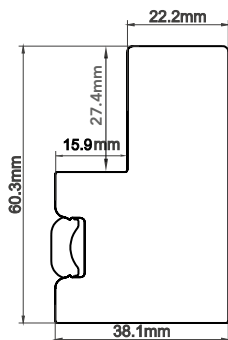

60mm

## PLAIN L FRAME

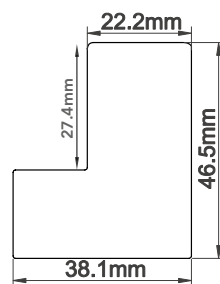

46mm

# FRAMING STYLES

## DOUBLE INSERT L FRAME

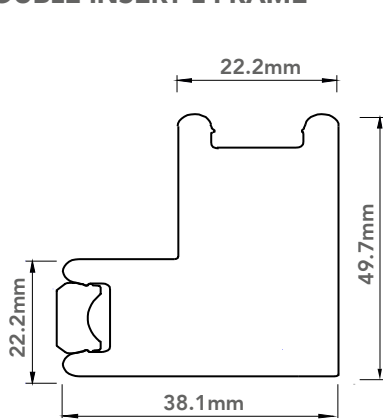

Double Insert L Frame  
50mm

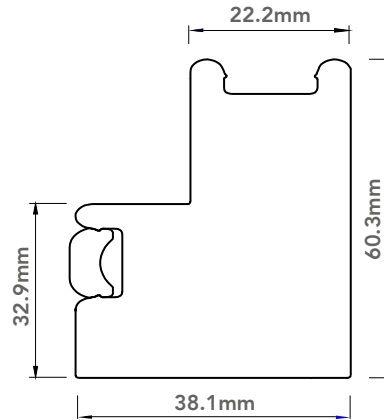

Double Insert L Frame  
60mm

**NB.** Please note that no screw holes will be pre-drilled for the Double Insert L Frame, but 76.2mm screws will be supplied loose in the hardware box.

## TIARA Z FRAME

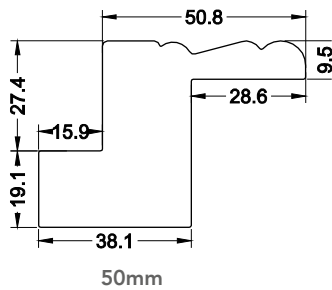

50mm

## TIARA Z SILL PLATE

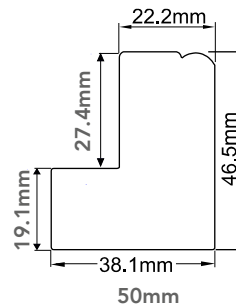

50mm

## CROWN Z FRAME

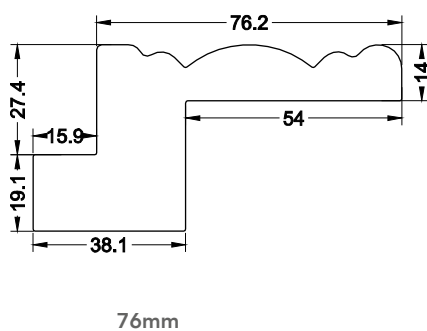

76mm

## CROWN Z SILL PLATE

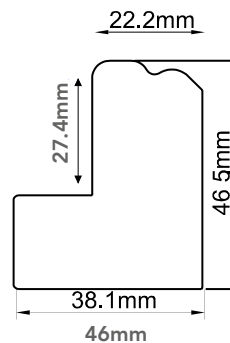

46mm



**BEADED Z**

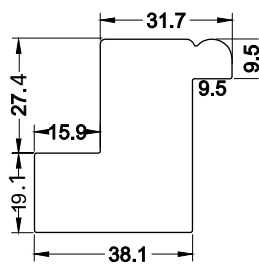

31mm

**BEADED Z SILL PLATE**

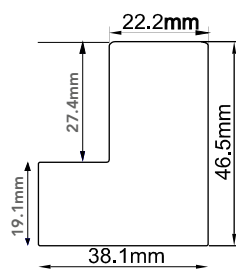

**BULLNOSE Z**

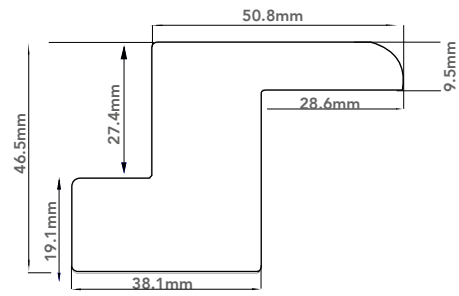

50mm

**BULLNOSE Z**

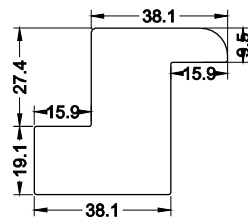

38mm

**BULLNOSE Z SILL PLATE**

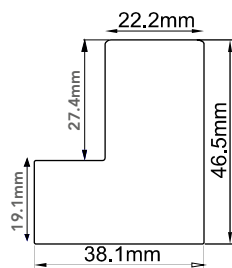

38mm

**DEEP BULLNOSE Z**

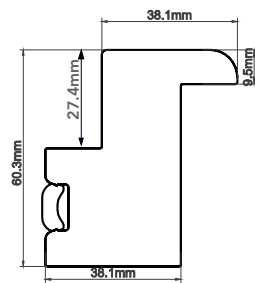

38mm

**RIDGE DECO FRAME**

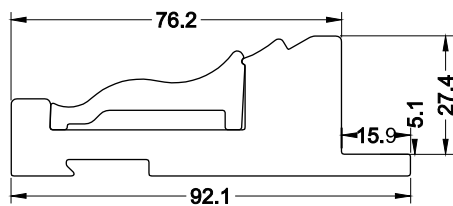

76mm

**RIDGE DECO SILL PLATE**

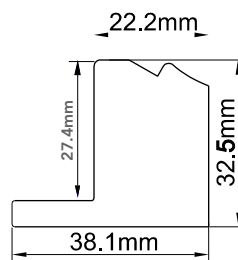

**SERRATE Z FRAME**

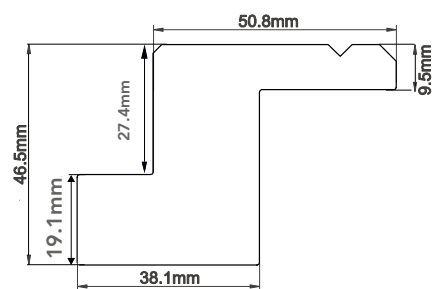

50mm

**SERRATE Z SILL PLATE**

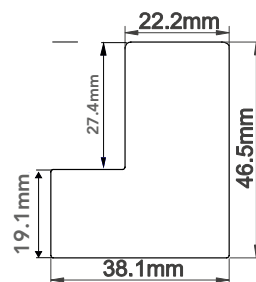

46mm

**CAMBER DECO FRAME**

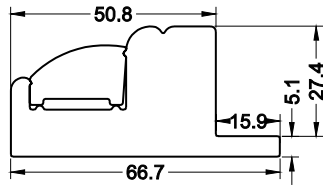

50mm

**CAMBER DECO SILL PLATE**

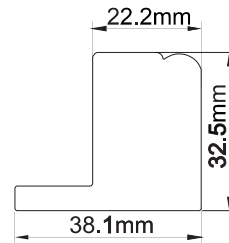

**HANG STRIP WITH INSERT**

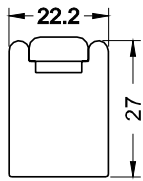

27mm

**MISSION FRAME**

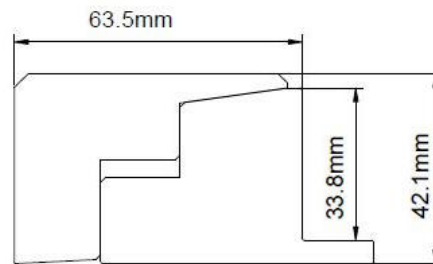

63mm

BACK TO TOP

**COVER STRIP\***

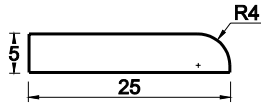

25mm

**COVER STRIP\***

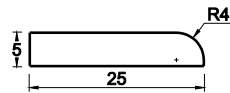

15mm

\* Cover strips are made in wood.

**T-POST**

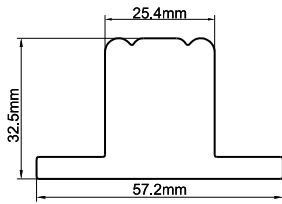

(Deco Frame)  
32mm

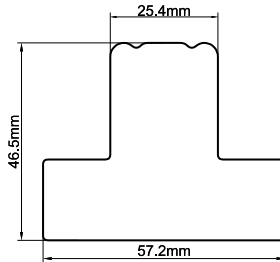

(L/Z/HS Frame)  
46mm

**NB.** Please note that horizontal T Posts over 1219mm are not covered by warranty.

Only vertical T Posts are adjustable.

**T-POST W/INSERT**

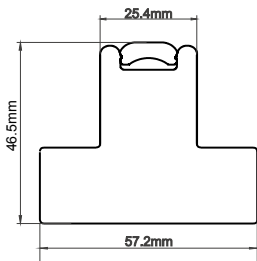

46mm

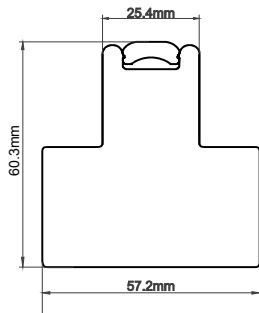

60mm

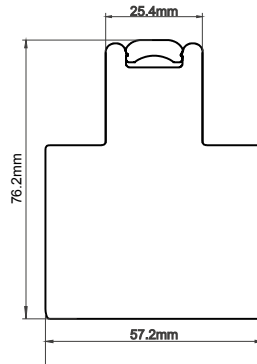

76mm

**NB.** Please note that horizontal T Posts over 1219mm are not covered by warranty.

Only vertical T Posts are adjustable.

**CORNER POST**

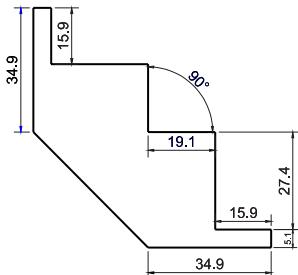

(Deco Frame)  
32mm

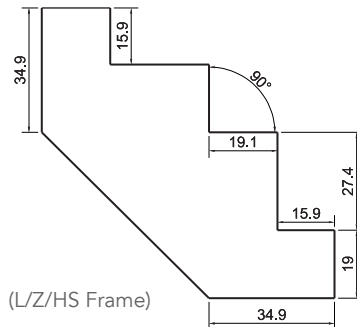

(L/Z/HS Frame)  
46mm

## BAY POSTS

Additional custom angles are also available in all materials.

[BACK TO TOP](#)

### 135° angle

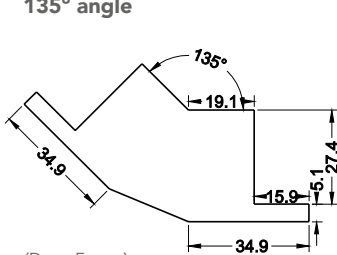

(Deco Frame)

32mm

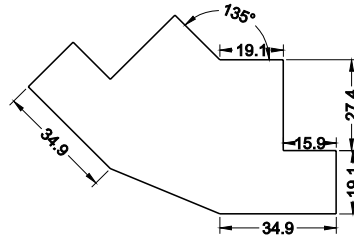

(L/Z/HS Frame)

46mm

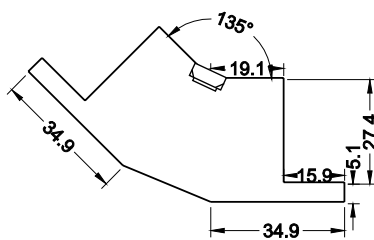

(Deco Frame)

32mm with insert

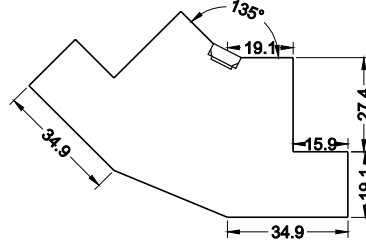

(L/Z/HS Frame)

46mm with insert

### Frames split when the frames length exceed the below limitation.

When frame lengths (including shutter frames, batten, fascia, header and tracks for track system) exceed the limitation, then the frames will be split as the below chart describes. Please review the chart for reference.

Shipping Method	Program	Frame Length (L) (mm)
Standard shipping	all programs	3630<L≤7260 (2 sections)/ L>7260 (3 sections)
Airfreight	all programs	3048<L≤6096 (2 sections)/ 6096<L≤9144 (3 sections)

## BATTENS

Battens can be butt-jointed as per the drawings below:



Battens and Panels identification: The PLANTATION SHUTTERS order number will be stamped on the bottom of each panel and one end of each corresponding batten to identify which one belongs to which item.

### Standard sizes:

#### Stock Battens are available in the following sizes

Made of Wood	Coated with PP
2.5mm x 27mm	25mm x 30mm
3mm x 15mm	25mm x 40mm
3mm x 20mm	5mm x 38mm
3mm x 30mm	10mm x 38mm
3mm x 60mm	15mm x 38mm
5mm x 45mm	20mm x 38mm
5mm x 63.5mm	20mm x 38mm
30mm x 40mm	30mm x 38mm
40mm x 40mm	35mm x 38mm
	40mm x 38mm

Other size battens are made of wood.

Minimum charge one linear meter per batten

Batten Identification: Order number will be stamped on one end of the battens to identify which batten belongs to which line.

### Build-out (Extension)

- For L/Z/Deco/Hang Strip Frame including T-Post, we will pre-attach the build-out of which the thickness is less than 50.8mm (including 50.8mm) by default;
- For L/Z/Deco/Hang Strip Frame including T-Post, when build-out is over 50.8mm, we will supply build-out loose with holes pre-drilled; also note that for frame not able to pre-drill holes, such as Beaded L Frame, we will supply build-out loose without holes pre-drilled, either.
- For all frames, we will add build-out per the order form. E.g., if the frame type is 76mm L Frame, and build-out is 10mm, we

will use 76mm L Frame added with 10mm build-out instead of changing the frame type to 50mm L Frame added with 36mm build-out. For bay/corner Post, we will supply build-out in every size pre-attached by default.

- Extension for Z Frame: If you want the timber to be added to bottom of Z frame like the drawing below on the right, please ALWAYS specify in the special note of the order form, "Add extension to light block section". The DEFAULT EXTENSION will be the left drawing.

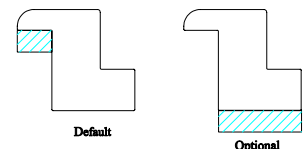

# 4. PANEL DETAILS

BACK TO TOP

## STILES

### Beaded

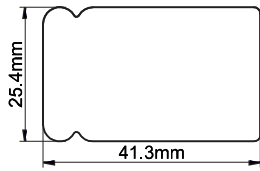

41.3mm Butt Stile

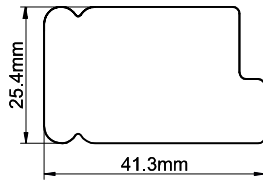

41.3mm Rebate Stile

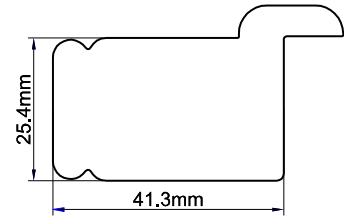

41.3mm D-Mould Stile

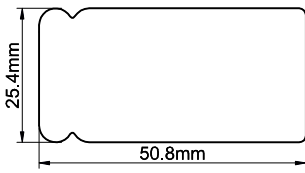

50.8mm Butt Stile

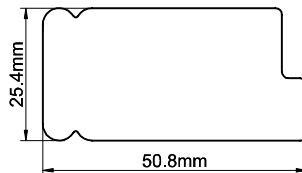

50.8mm Rebate Stile

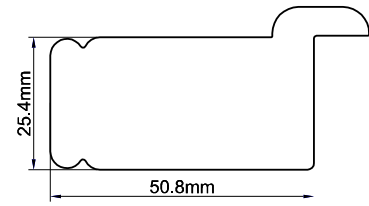

50.8mm D-Mould Stile

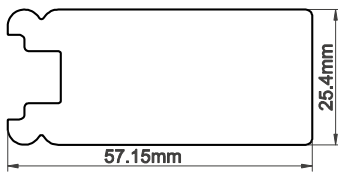

57mm Butt Stile

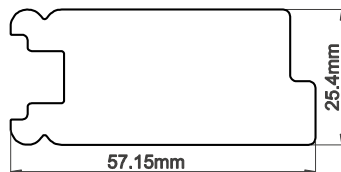

57mm Rebate Stile

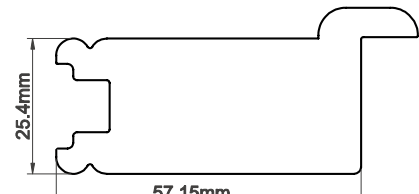

57mm D-Mould Stile

### Plain

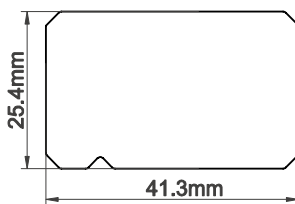

41.3mm Chamfer Butt Stile

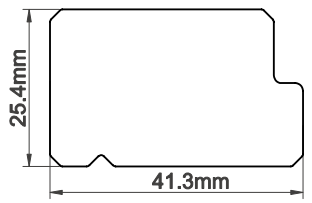

41.3mm Chamfer Rebate Stile

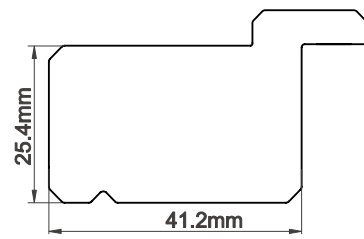

41.3mm Chamfer D-Mould Stile

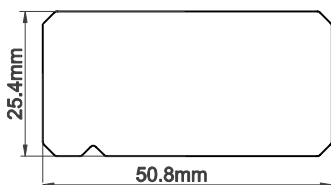

50mm Chamfer Butt Stile

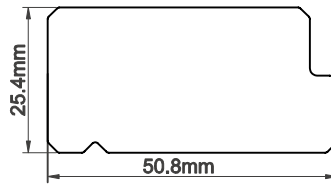

50mm Chamfer Rebate Stile

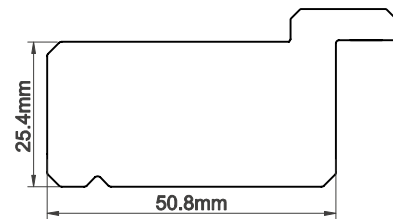

50mm Chamfer D-Mould Stile

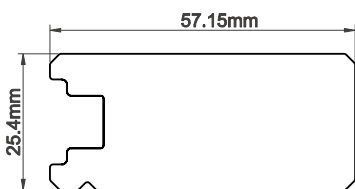

57mm Chamfer Butt Stile

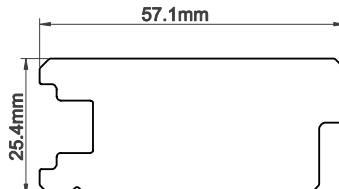

57mm Chamfer Rebate Stile

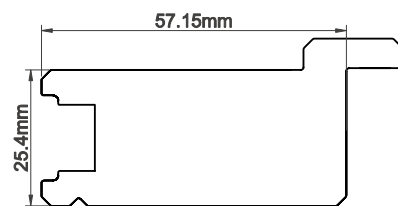

57mm Chamfer D-Mould Stile

## RAILS

The factory will decide the size, unless otherwise specified in the notes section on order form. The top and bottom rail will be the same size if there is no divider rail. If you need different size rails, please specify.

We suggest ordering shutters for the same customer at the same time, so that the rail sizes will match as accurately as possible.

Please note the standard top/bottom rail sizes should be within 69.85mm~165.1mm.

For regular shutters, the increments for the rail size is 3.175mm.

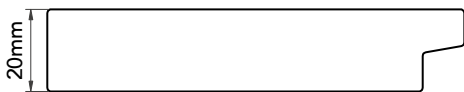

## STANDARD MID-RAILS

The Mid-Rail size is 76.2mm high. Different mid-rail sizes cannot be ordered in MDF.

If the panel height is greater than 1879mm one or more mid-rails are required. If the height from the centre of the mid-rail to the top of the top rail or bottom of the bottom rail is 1879mm or more, then another mid-rail is required. Mid-rail positions should be specified at time of ordering. If the order is placed with no mid-rail then all warranties on the order are automatically waived.

Divider rail:  
Standard divider rail is 76.2mm

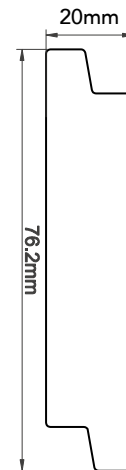

## MID-RAIL continued

Specified rail position is taken from the base of the shutter set to the centre point of the rail, except for solid based which is from the bottom to the top of the mid-rail.

The centre rail can deviate by + or - by the amount of millimetres shown below. If the mid-rail is to be exact with no deviation then this must be noted on the order under the notes when placing the order.

Louvre Size	Allowable +/- Deviation
47mm	19mm
63mm	25mm
76mm	31mm
89mm	38mm

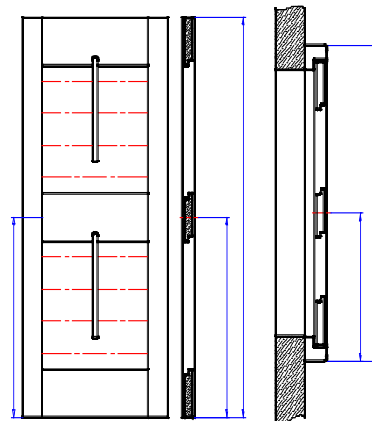

## LOUVRES



47mm Elliptical Louvre

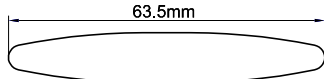

63mm Elliptical Louvre

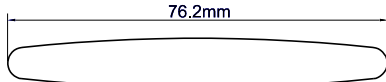

76mm Elliptical Louvre

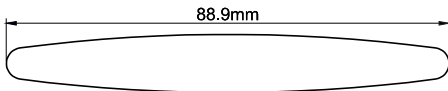

89mm Elliptical Louvre

## LOUVRE DEPTH CLEARANCE

This diagram is to help determine the adequate depth inside the window opening for unobstructed louver rotation. The figures given are measured from the back of the panel to the window.

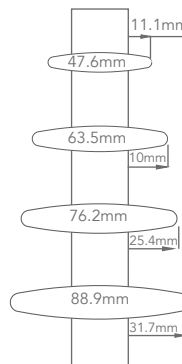

## LOUVRE PIN

Louvre pins are used to ensure louver tension. In addition a tension screw is inserted into one louver in the panel. This is the same for all louver sizes. Access holes are drilled in the in the stile for each panel to allow the tightening or loosening of the tension screw, to adjust the louver tension. Please note therefore additional holes will be visible in the stiles.

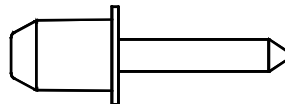

## TILT RODS

### Standard tilt rod

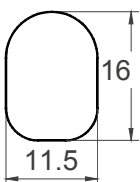

### Silent tilt rod

Silent Tilt rods are integrated into the stile and are not visible. Silent tilt rods are available in 63mm, 76mm and 89mm. The 47mm does not have this option.

The Silent Tilt rod will automatically be split into 2 parts when the number of louvers connected to the silent tilt rod exceeds the following limit.

Louvre Size	Louvre Quantity
64mm	24
76mm	19
89mm	16

### Panel Height Range

1289mm - 1385mm
1276mm - 1372mm
1289mm - 1385mm

If the louver quantity exceeds the above limit, the gear tilt control will be equally split into halves. If the louver quantity is odd the bottom section will have one more louver than the top section. If the panel has a divider rail, and the louver quantity above divider rail or below divider rail exceeds the above limit, split tilt rods are also required.

### OFFSET TILT RODS

Offset tilt rods can be ordered. The standard offset is 25mm from the centre of the tilt rod to the end of louvre on hinge side. If a different offset is required please specify the position from the centre of the tilt rod to the end of the louvre on the hinge side in the short notes on the order form.

The centre of the tilt rod will be 25mm from louvre end on hinge side of the panel. For Fixed panels, the offset tilt rods will be positioned on the left side for all panels. For special shaped panels, the offset tilt rods will be on the higher side of the stile.

### OFFSET TILT ROD FOR MULTI-FOLD SHUTTERS

Multi-fold panels will be made with the tilt rod offset from the centre to enable panels to be folded flat without tilt rods obstructing one another. The standard offset for the tilt rod is 7mm from the centre, i.e. tilt rod will be 7mm to the left of centre for left panels, and 7mm to the right of centre for right panels. Rebates between panels are made right over left. Bi-Fold panels (LR or LLRR) do not require offset tilt rods.

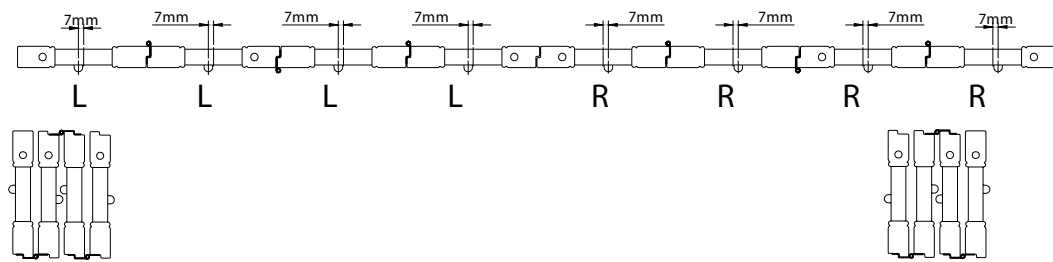



# 6. HARDWARE

[BACK TO TOP](#)

## Hinges:

Self-Mortice hinges are provided They are pre-mounted on panels and frames by two screws in the slotted holes. The screw for the third rest hole should be installed at installation. The hinge pins are removable.

### Hinge Colours

Antique Brass, Bright Brass, Black, Nickel Plated, Stainless Steel (Surcharge), Brushed Nickel Plated (Surcharge), White, Pearl, Bisque, Pure White

## Please Note:

Centre of hinge to top/bottom of panel is 76mm.

## For the HARDWOOD program

Panel height	No. of hinges
<=1219mm	2
1219mm~1981mm	3
1981mm~2438mm	4
2438mm~3048mm	5
>3048mm	6

## MAGNETS

Round magnets are pre-mounted on the panels and the catch is pre-mounted on the frame when the order is 'OD' type. An 'L' shaped magnet catch is included in the hardware box when ordering 'OP' type.



CATCHPLATE



MAGNET

## HANDLE OPTIONS

Handle A and B are available to order in Nickel Plated only. Please specify the handle you require along with the quantity on the notes section of your order card, they will not be pre installed but supplied loose in the hardware box. (Surcharge will apply).



Handle A

Handle B

## HOFFMAN KEYS

These are supplied and are used to join frame corners together.



## PANEL FEET

Panel feet are mounted on the bottom of panels when ordering 'OD' type and are included in the hardware box.

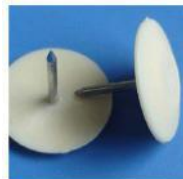

## L SHAPE MAGNET CATCH

When ordering 3 sides frames with the gap more than 2.5mm, we will supply L shape magnet catch.



## SIDE MAGNETS

When selected we will add a magnet situated in the side of stile (1). It can be selected where a Left and Right panel meet where there is no lightblock or bottom frame to secure the panels. The magnets will act to keep the panels together (2). Please note that the side magnet is not available if a rebate stile has been selected.

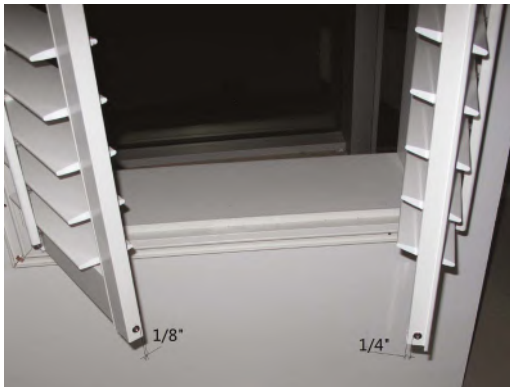

(1) Magnet shown in side of stile



(2) Magnet keeping panels together

The side magnet can be selected where you have:

- a) Door shutters that require bottom clearance.
- b) Tier on Tier shutters without horizontal T post. The side magnet will be installed on the top of the bottom tier and the bottom of the top tier (3).
- c) Café style shutters with upside down goal post frame (4).
- d) Window that do not have a light block or bottom frame (5).

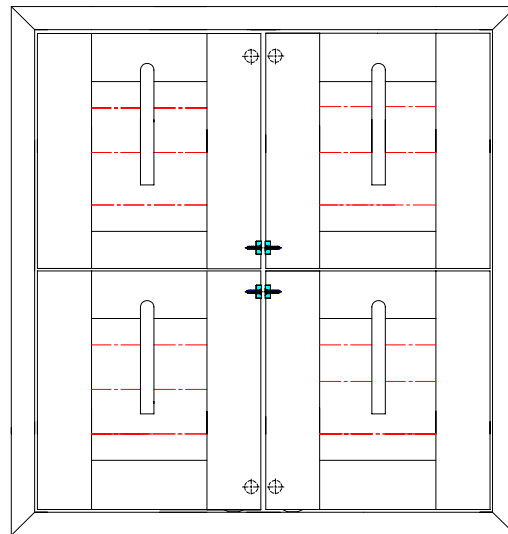

(3) Double Hung shutter without horizontal T post

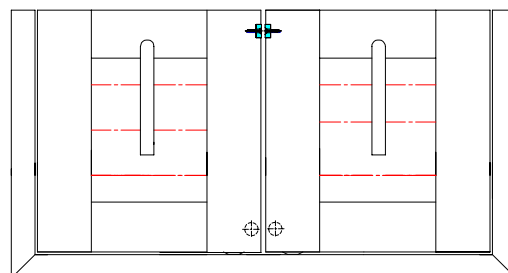

(4) Café Shutter

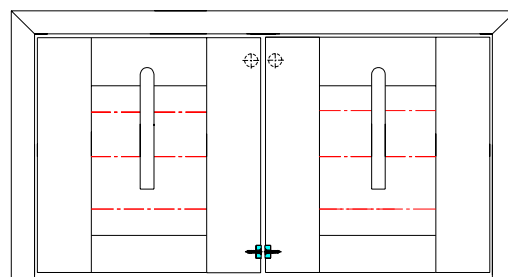

(5) No frame or light block on either top or bottom

**BOLT & RING PULL**



1. Barrel Bolt

Can be used for hinged shutter and Bi-fold track shutter to fit for panels. Based on the size of the bolt, 41.3mm stile cannot be used for this product.

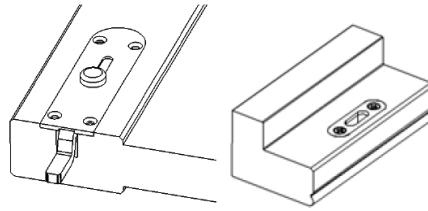

2. Ring Pull

Can be used for hinged shutter and track shutter. Based on the size of the ring pull, 41.3mm stile cannot be used for this product. The location of the ring pull, refer to the bolt location.



3. Security Bolt

Can only be used for hinged shutter. Based on the size of the security bolt, 41.3mm stile cannot be used for this product. Please note you will need to note the location of the security bolt in the notes section of the order card.

**RING PULL & BARREL BOLT**

LL

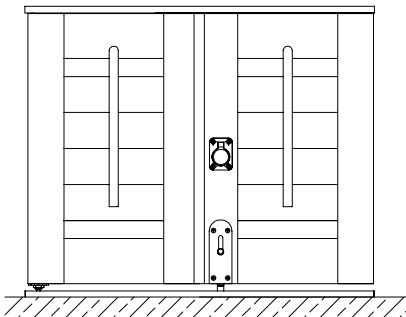

RR

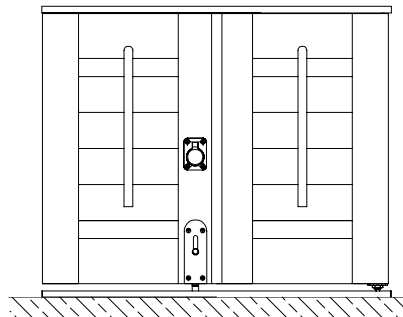

LLL

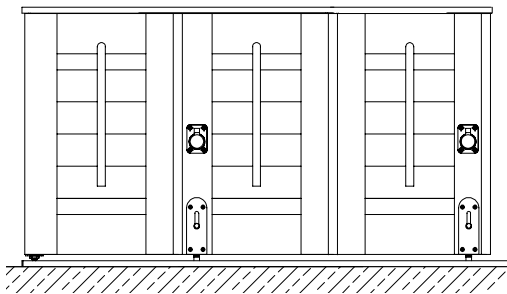

RRR

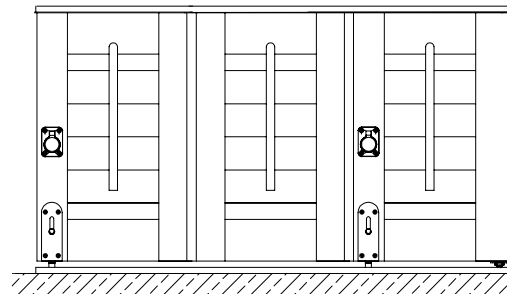

LLRR

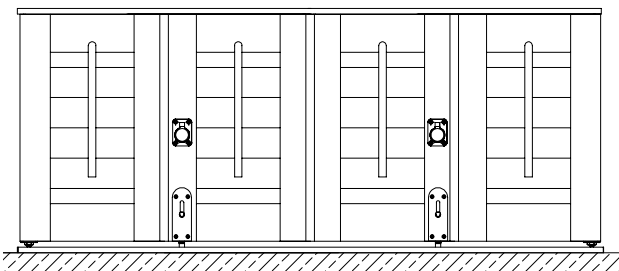

LLLL

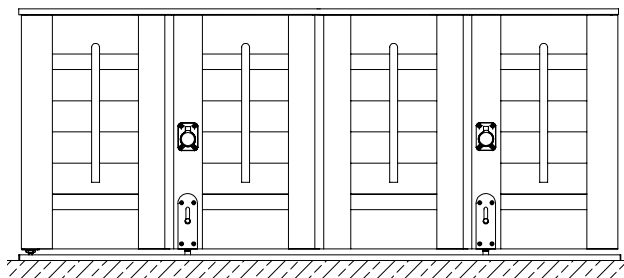

**RING PULL & BARREL BOLT Cont.**

BACK TO TOP

RRRR

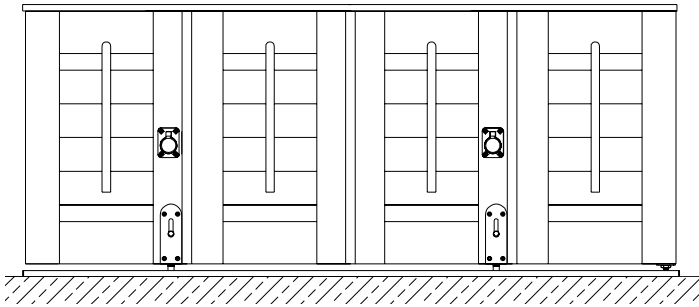

The bolt location for both track system shutters and regular shutters would be the same. The general principle is that the bolt position will avoid the stile which will install the spring-loaded guide at bottom (same stile as the Wheel carrier).

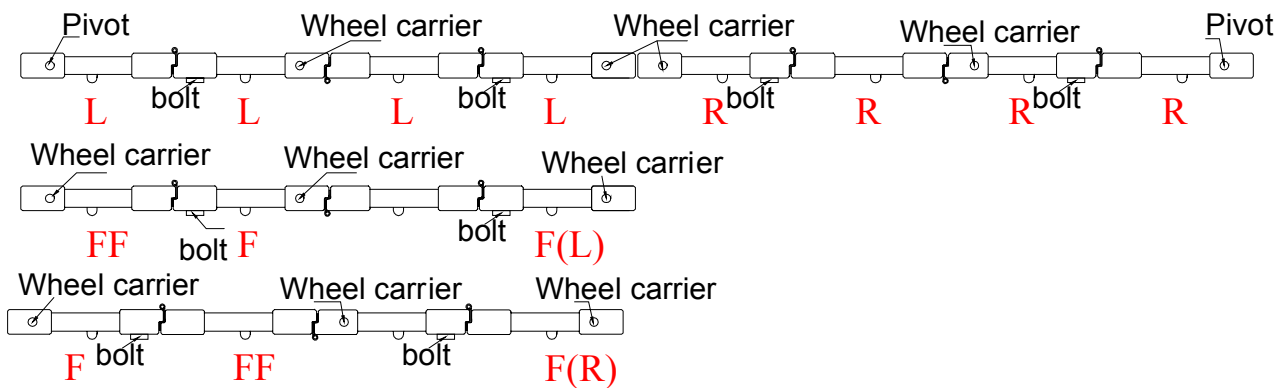

**Ring pull:** for easy opening and closing (Not available for 1.625" /47mm Stile)

**Ring Pull and Barrel Bolt:** Customer needs to specify ring pull location on the order form. Ring pull location principle for Floating Panels: (same as the location of 90° Bifold Track)

1. When floating panel config is in pairs, it will be split into halves, the left will be for LL and the right will be for RR. So the ring pull location for FF/FF, FF/FF/FF/FF will be same as that of panel config as LL/RR, LL/LL/RR/RR.
2. When floating panel config is FF, the ring pull location will be same as that of panel config LL.
3. When floating panel config is singular, it will be split into 3 sections, the left and mid sections are for LL and the right section is for RR. So the ring pull location for FF/FF/FF, FF/FF/FF/FF/FF will be same as that of LL/LL/RR, LL/LL/LL/RR/RR.

Please note the ring pull finish will match with the hinge finish.

Please see the matching chart below:

Hinge	Pure White	White	Bisque	Pearl	Black	Nickel	Brushed Nickel	Antique Brass	Bright Brass	Stainless Steel
Ring Pull	White	White	Bisque	Pearl	Black	Brushed Nickel	Brushed Nickel	Antique Brass	Bright Brass	Brushed Nickel

Position: For different panel configuration, please refer to the location of bolt to show on which stile the pull will be fixed.

Hinge	Crisp Linen	String	Sea Mist	Stone Grey	Brown Grey	Taupe Grey
Ring Pull	Bisque	Bisque	Brushed Nickel	Brushed Nickel	Brushed Nickel	Brushed Nickel

BACK TO TOP

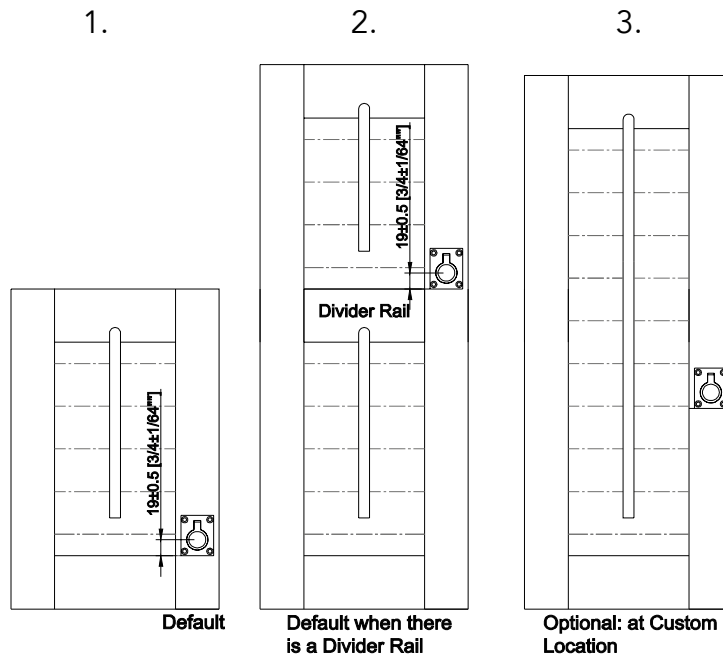

**Position:**

1. Above Bottom Rail (Default)
2. Above 1st Divider Rail (Default when there are Divider Rails)
3. Custom Location

If both bolt & ring pull are specified, the distance between them is 2 3/4" (70mm), and the ring pull location is 6 3/4" (170mm) from the bottom of panel.

When there is no mid rail, ring pull will be just on the top of Bolt (2 3/4" / 70mm above bolt) as default location; if there are mid rails, bottom of ring pull lines up with top of the 1st mid rail as default location.

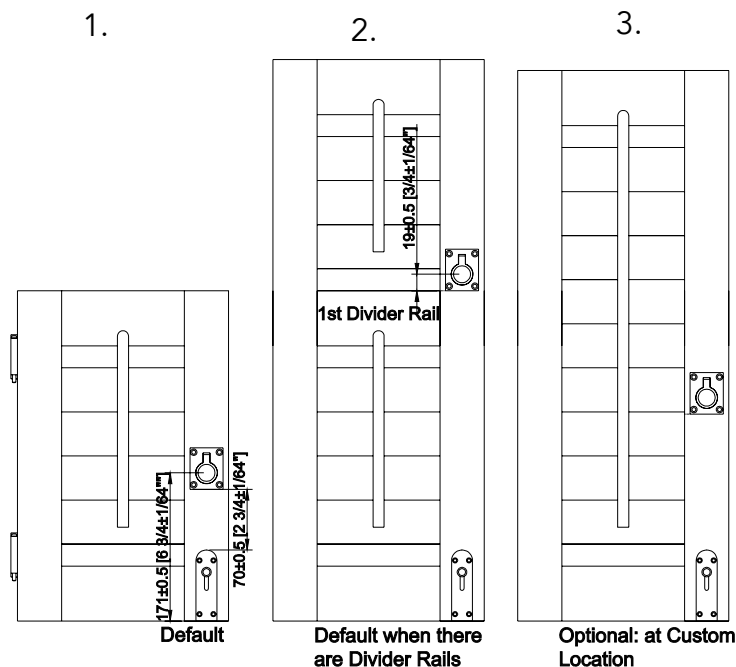

**Position:**

1. 2 3/4" (70mm) Above bolt (Default when both Ring Pull and bolt are specified)
2. Above 1st Divider Rail (Default when there are Divider Rails)
3. Custom Location

**Measurements:**

Window size: Measure from the bottom of the window to the centre of the ring pull

Max frame-to-frame: Measure from the bottom of the frame to the centre of the ring pull

## PANEL CONFIGURATIONS

If you order shutters in OVERALL PANEL SIZE & OD OF FRAME, panel configuration is required. Please specify if the stile type required is Rebate or D-Mould.

### 1 panel: L/R



### 2 panels: LL/RR/LR

A) Rebate stile

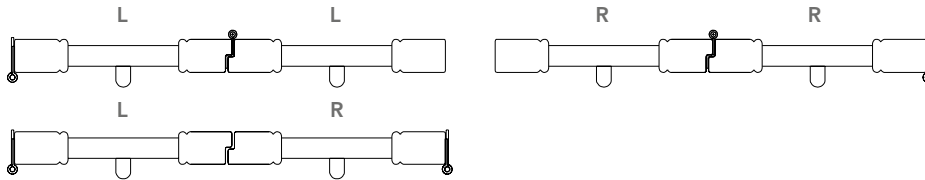

B) D-Mould stile

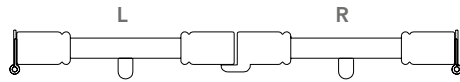

### 3 panels: LLR/LRR

A) Rebate stile

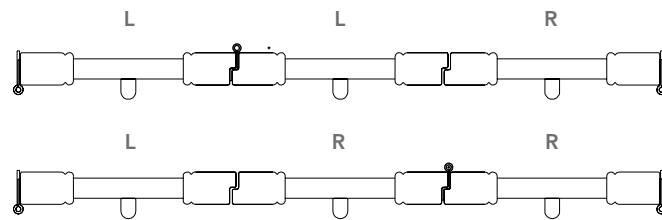

B) D-Mould stile

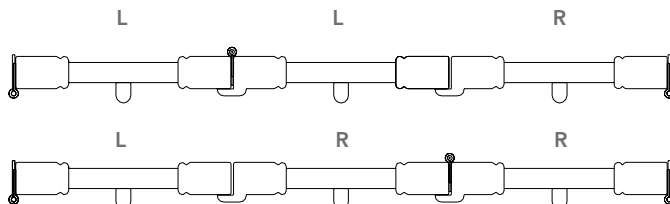

**4 panels: LLRR**

A) Rebate stile

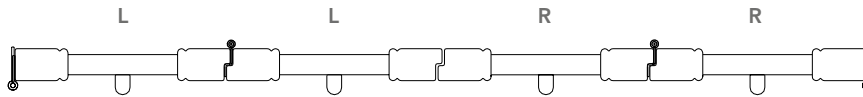

B) D-Mould stile

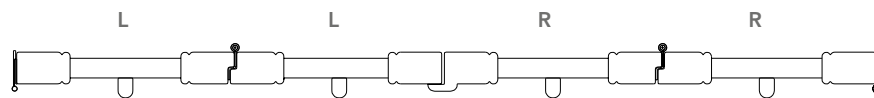

**Offset tilt rod for multi-fold shutters**

For multi-fold panels, we will place the tilt rod offset from the centre. By doing so, panels can be folded flat without tilt rods obstructing each other. The standard offset for the tilt rod is 7mm from the centre, i.e. tilt rod will be 7mm to the left from the centre for the left panels, and 7mm to the right from the centre for the right panels. Besides, the Rebate is made with right panels over left ones for both the panels folded to left and to right.

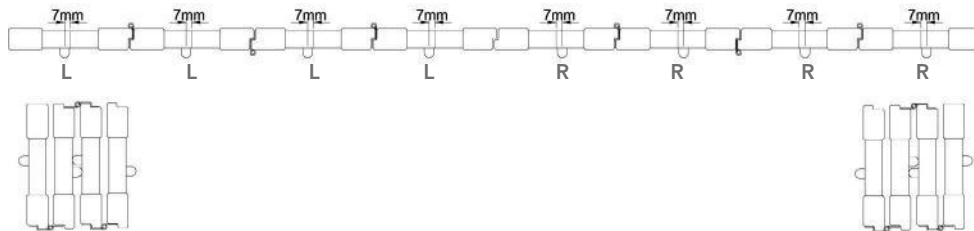

\* For 2 panels (LL/RR) and 4 panels configuration (LLRR), there is no need to offset the tilt rod.

## PANEL SIZE LIMITATIONS

### Panel structure

The PLANTATION SHUTTERS shutter panel is made up of several parts. To help you understand the panel construction please see photograph.

**MOUSE HOLE**

**STILE**

**TILT ROD**

**LOUVRE**

**RAIL**



Louvre Size	Width				Height			
		Maximum			Maximum number of untracked Multi-fold panels	Minimum	Maximum without mid rail	Maximum with mid rail
Single hung	Bi-fold hinged shutter/ Multi-fold with Top and Bottom track	Multi-fold hinged shutters & multi-fold with Top track only. Number of panels ≤ 4						
47mm	152mm	750mm	660mm	550mm	4	250mm	1981mm	3000mm
64mm	152mm	890mm	660mm	550mm	4	250mm	1981mm	3000mm
76mm	152mm	890mm	660mm	550mm	4	250mm	1981mm	3000mm
89mm	152mm	890mm	660mm	550mm	4	250mm	1981mm	3000mm

**NB:** Where the panel size limits above are exceeded, warranty on the order line is waived automatically.

**NB:** When a single hung panel width is less than 228.6mm and used with the following frames: Deco, L, Z and Hang Strip, the stile opposite to the hinge will be rebated.

If panel height is over 1981mm, a Mid Rail is required and if the panel has a Mid Rail but the height from the centre of the Mid Rail to the top of the top rail or to the bottom of bottom rail is still over 1981mm, another Mid Rail will be required.

If you do not specify the Mid Rail location, the order will be held to confirm if a Mid Rail is required. However, if you specify no Mid Rail, you will waive your warranty and manufacture will proceed as per your instructions.

### Shutter used for door without bottom support:

In situations where shutters are used for door applications, which do not have any support underneath the panels, the customers must inform PLANTATION SHUTTERS when placing this type of order. (See the following specs for Shutters used in Door applications)

Please note:

- (1) The factory will add extra hinges to support the panels.
- (2) Bigger and Stronger Top and Bottom rails will be added to reduce the probability of the panels sagging and increase shutter intensity.
- (3) If customers fail to notify PLANTATION SHUTTERS that the shutter will be used in door applications, the customers will be responsible for the cost of the any re-order that is submitted.

Please see the following chart for details.

Panel Configuration	
L,R,LR	LL, RR, LLRR
Manufactured with warranty	Must order it with track, or waive warranty.



## PANEL WEIGHT

Panel Weight		
Material	Louver size	Weight (kg)/m <sup>2</sup>
Hardwood	47mm	7.80
	63.5 mm	7.31
	76.2 mm	TBA
	88.9 mm	7.88

\* Average Weight

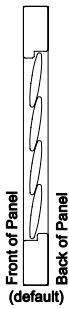
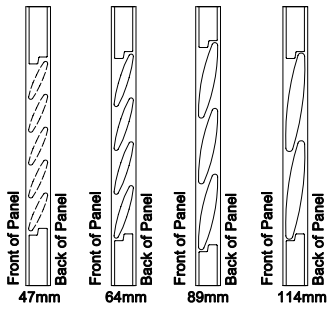
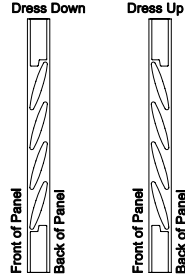
FIXED LOUVRE OPTIONS	
	Fixed Closed Position      Fixed Open Position
<p>Available in two positions: closed or open at angle.</p>	 
<p>The standard default orientation for Fixed louvres is Closed 'Dress Down' with the bottom edge of louvres to the front of the panel. 'Dress Up' option is also available if specified on the order form.</p> <p><b>NB.</b> Note that normal orientation for <i>adjustable louvres</i> when closed is in the 'Dress Up' state.</p>	

# 7. SIZING AND MEASURING

## ORDER SIZE DEFINITION

### Overall Panel size (OP):

The size given is the overall panel size. The width does not include the hinge space from panel to batten on the left & right side, but does include the gap between panels, the standard gap is 2mm between panels and we will calculate the single panel width based on this measurement (see diagram below). The height given must be net panel height. We will pre-mount the hinges and the magnets and include panel feet and L shape magnet catches in a hardware box. The stile can be Rebate or D-mould, please specify in the relevant section of the order form.

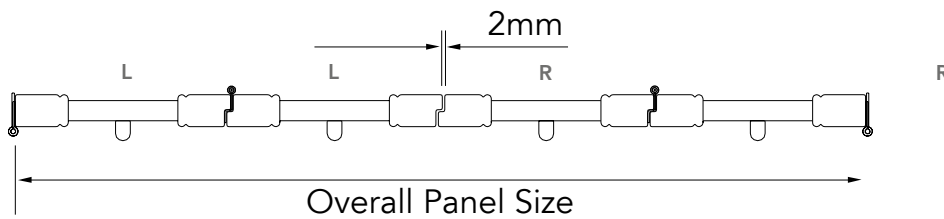

### OD of frame:

Size given is "Outside Dimension" of the shutter; we will pre-mount the hinges and the magnets, and will include all the necessary hardware in a hardware box. The stiles can be Rebate and D-Mould stile, please specify on the order form.



Camber Deco Frame 50mm: Can only be ordered as outside mount, the size given must be OD of frame size.

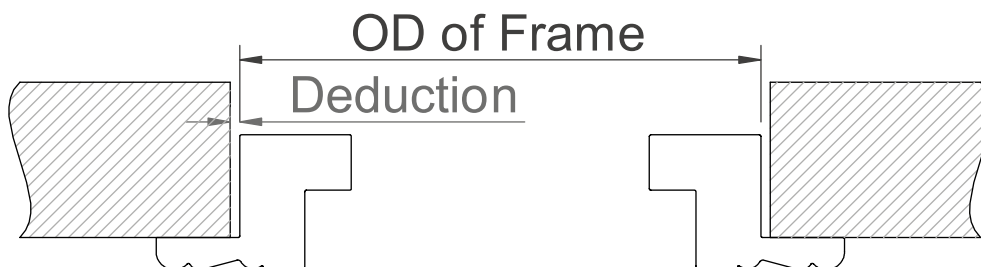

"Z" frame: Can only be ordered as inside mount, the size given must be OD of frame size. (Backside of Z frame, refer the drawings).

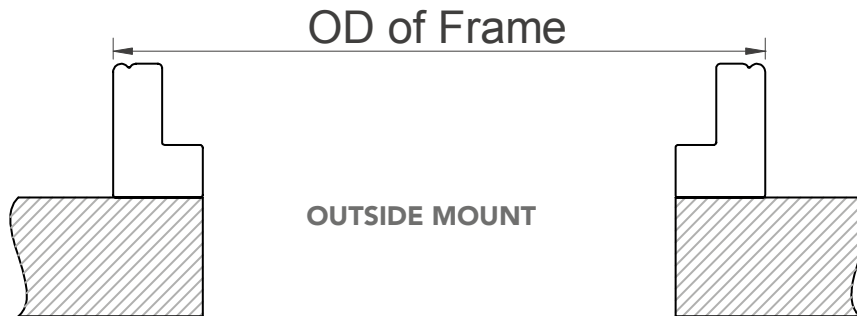
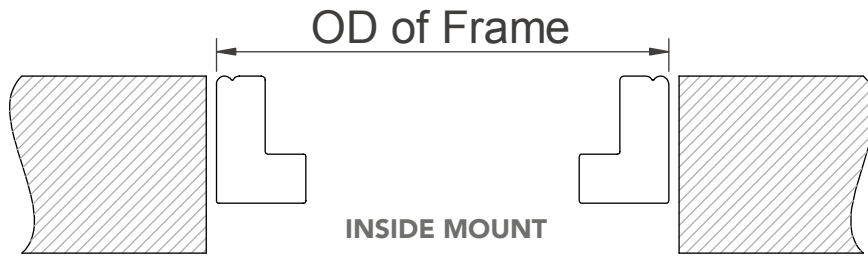

"L" frame: Can be ordered as inside mount and outside mount, size given must be OD of frame size.

## TOLERANCES

**Width:** The width of the panel can be plus or minus 1.6mm from the order width.

**Height:** The height of the panels can be plus or minus 1.6mm from the order height.

**Mid Rail location:** Mid Rail location may be off by half a louvre space. Measure from bottom of bottom frame to centre of Mid Rail if order OD of frame, and from bottom of panel to centre of Mid Rail if order net panel size or overall panel size.

For 47mm louvre can be off by +/-19mm.

For 63mm louvre can be off by +/-25mm.

For 76mm louvre can be off by +/-31mm.

For 89mm louvre can be off by +/-38mm.

For 114mm louvre can be off by +/-51mm.

## MOUNTING TYPE

**Café style shutter:** Please specify on the order form if the shutter is a café style. We will finish the top of the panels and one end of the battens.

If a café shutter is required with a 3 sided frame, it should be 3 sides inverted.

**Tier on Tier:** The standard gap between the top tier and bottom tier is 2.5mm.

**Full height:** Regular shutters running the full height of a window.

Plantation Shutters Ltd  
Unit 10 River Reach Business Park  
1 Gartons Way  
Battersea  
London  
SW11 3SX  
Tel: 020 8871 9222

[www.plantation-shutters.co.uk](http://www.plantation-shutters.co.uk)

**Emma - Sales Manager**  
[emma@plantation-shutters.co.uk](mailto:emma@plantation-shutters.co.uk)