

# SILKWOOD TECHNICAL SPECIFICATIONS



# SILKWOOD SPECIFICATIONS CONTENTS

To go to required section click [coloured headings](#) below

<b>Section 1</b>			
Introduction		3	
Specifications		4	
Colours		5	
<b>Section 2</b>			
<b>Installation Styles</b>		6	
Full Height			
Cafe Style			
Tier on Tier			
Tracked Shutters			
Unsupported Shutters			
<b>Section 3</b>			
<b>Framing styles</b>		7	
Beaded			
Bullnose L			
Insert L			
Plain L			
Tiara Z		8	
Crown Z			
Beaded Z		9	
Bullnose Z			
Ridge Deco			
Camber Deco			
Serrate Z			
Insert Hang Strip			
Cover Strip		10	
<b>T Posts</b>			
L/Z			
Deco			
Insert T			
<b>Corner Posts</b>			
L/Z			
Deco			
<b>Bay Posts</b>		11	
L/Z			
Deco			
<b>Battens</b>		12	
<b>Section 4</b>			
<b>Panel details</b>		13	
Stile			
Rails		14	
Louvres			
Flat Louvres			
Louvre pin			
Tilt Rods			
Standard tilt rod			
Silent tilt rod			
Offset tilt rod		16	
Offset tilt rod for Multi-fold Shutters			
<b>Section 5</b>			
<b>Room Darkening</b>		17	
<b>Section 6</b>			
Hardware		22	
Bolts & Ring Pulls		24	
Panel Configurations		28	
<b>Section 7</b>			
<b>Sizing &amp; Measuring</b>		32	
Order Size Definition			
Overall Panel size (OP)			
Overall Dimension of frame (OD)			
Tolerances		33	
Mounting Type			
<b>Section 8</b>			
Contact Info		34	

# 1. SILKWOOD INTRODUCTION

**Aesthetics:** Silkwood is a MDF shutter with ABS louvres which is painted so that it closely resembles the finish of a painted Hardwood shutter. 22 contemporary colours are available in the range.

**Hardwearing:** Silkwood is coated in a paintable polypropylene sleeve which is very hardwearing and helps to protect the shutter from changes in ambient temperature and this reduces the likelihood of in-situ moisture changes and the risk of warping and twisting.

**Sustainability:** All of PLANTATION SHUTTERS's MDF is produced from managed plantation Radiata Pine forests that reach maturity in about 30 years. This MDF is viewed favourably as substitutes for tropical Hardwoods which take close to 200 years to reach maturity. 70% of the MDF manufacturing energy requirements on site are for producing heat and as the plant generates almost all of its own heat requirement by burning wood residues this is very energy efficient. This is a form of bio fuel and is considered greenhouse gas neutral under the Kyoto protocol.

**Frames:** 26 different frames are available in this range.

**Stiles:** Please note the stiles are manufactured in a beaded and plain stile.

**Louvres:** Silkwood is available in 47mm, 63mm, 76mm 89mm, 114mm louvres. Due to the louvres being manufactured in ABS the panel weight of the shutter has been reduced. This means that single hung panels can now be up to 915mm wide as opposed to 63mm while multiple panels are available up to 610mm in width.

NB the number of panels that can be hinged together remains. Over and above the shutters must be tracked. Please see the panel limitations chart.

**Colour palette:** There are a total of 22 contemporary colours available and these can be viewed in the generic paint keyring.

## PANEL SIZE LIMITATIONS

Louvre Size	Width			Height		
	Minimum	Maximum		Minimum	Maximum	Mid rail
		Single hung	Bi-fold hinged shutter/ Multi-fold with Top and Bottom track			
47mm	152mm	610mm	610mm	250mm	3000mm	H>1981mm
63mm	152mm	915mm		250mm	3000mm	H>1981mm
76mm	152mm	915mm		250mm	3000mm	H>1981mm
89mm	152mm	915mm		250mm	3000mm	H>1981mm
114mm	152mm	915mm		250mm	3000mm	H>1981mm

## SPECIFICATIONS

Material	MDF Panels with ABS Louvres
Panel Weight per sq. metre	6.24 - 8.5kg
Paint Colours	22
Stain Colours	✗
Custom Colours available (solid colours only)	✓
Louvre sizes	47mm 63mm 76mm 89mm 114mm
Max single panel width	610mm : 47mm 915mm : REST
Max bi-fold panels width	610mm : ALL
Max number of panels hinged together	2
Max and min panel heights	3000mm 250mm
Solid Panels available	✗
Special shapes	✗
Custom Bay Post angles	✓
Stile Type	Beaded & Plain
Fixed Louvres	✓

## COLOURS

Please note. Colours may vary slightly between dye lots. Shutters for the same installation should be ordered together to avoid variations in colour. Colours may vary slightly from colour samples. For this reason, colour samples should be updated annually.

### COLOUR OPTIONS

BERMUDA PAINT OPTIONS (22 COLOURS)				
Colour ID	Colour Name		Default Hinge Colour	Optional Hinge Colour
001	Pure White		Pure White	1. Pure White 2. White 3. Pearl 4. Bisque 5. Antique-Brass 6. Bright-Bass 7. Stainless 8. Black 9. Nickle-Plated 10. Brushed Nickle-Plated
002	Extra White		White	
003	Silk White			
004	Bright White			
006	Pearl		Pearl	
007	Ivory Lace			
009	Creamy		Bisque	
011	Cameo			
012	Crisp Linen			
013	Bisque			
014	Alabaster			
016	Butter			
016	String			
030	Moondust			
032	Sea Mist		Nickel Plated	
048	Chai			
049	Stone Grey			
051	Brown Grey			
053	Clay			
066	Winchester White 2010		Pearl	
072	Mattingley 267		Nickel Plated	
080	Taupe Grey			

**Please note: custom colour is available with a surcharge, however black colours are not available as custom colours in Silkwood**

Due to the nature of material manufacturing, colours may vary slightly between dye lots. Please order shutters for the same home at the same time. Slight variations may also occur between the finished products and the colour swatches you use.

## 2. INSTALLATION STYLES

BACK TO TOP



### FULL HEIGHT

Shutter covering the full height of aperture.



### TIER ON TIER

Shutter is split into two halves so the top and bottom panels can be independently operated / opened fully. The standard gap between top tier and bottom tier is 2.5mm. For multi-fold tier on tier shutters only 3 or less multi-fold panels are within warranty.

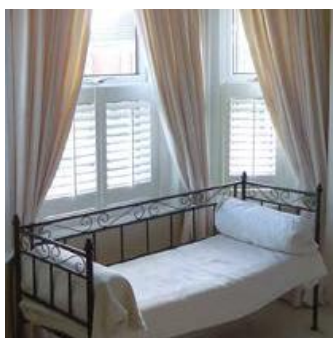

### CAFE STYLE

Shutter covering only the lower portion of aperture providing privacy and light control but leaving the top portion un-shuttered to maximise light, where privacy is not required.



### SHUTTERS USED AS DOORS

In situations where shutters will be used for a door application which does not have support underneath the panels, the customer must inform PLANTATION SHUTTERS when placing the order.



### TRACKED SHUTTERS

#### Bi-Fold

Shutters suspended from a top track hinged together in a bi-fold configuration to allow them to be folded back to the end of the track at 90° or 180°. Suitable for use with patio doors, wardrobes or as a room divider. May be specified and fitted with or without side frames.

#### By-Pass

Shutters suspended from a top track. Panels slide behind or in front of one another to open or close. Suitable for use with patio doors, room dividers and wardrobes. May be specified and fitted with or without side frames.

\* Refer to the separate track specifications for further details.

#### Panel Configuration

L, R, LR	LL, RR, LLRR
Manufactured with warranty waived	Only available with a tracked installation. Not covered by warranty.

#### Please note:

1. The factory will add extra hinges to support the panels
2. The factory will add a larger and stronger top and bottom rail. This will reduce the risk of panels sagging.

N.B Customers will be responsible for any EDR re-order where there has been a failure to notify PLANTATION SHUTTERS that the original shutter order was for a door application.

# FRAMING STYLES

## BEADED

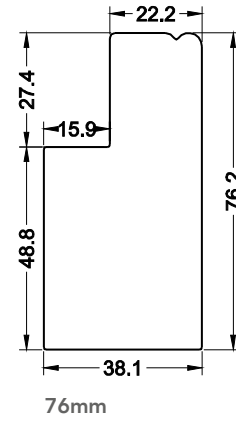
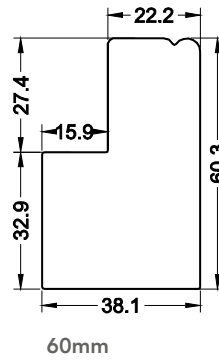
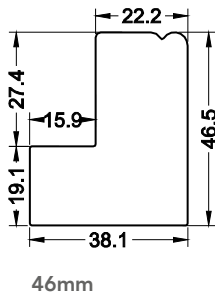

## INSERT L

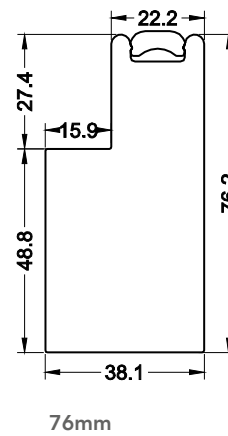
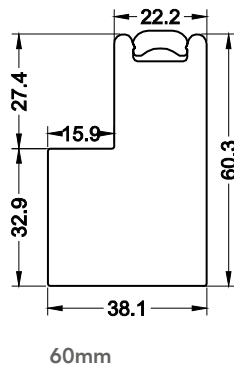
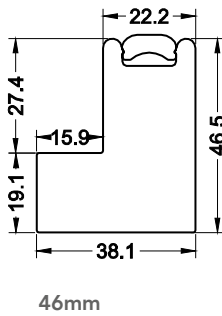

## PLAIN DEEP L W/INSERT

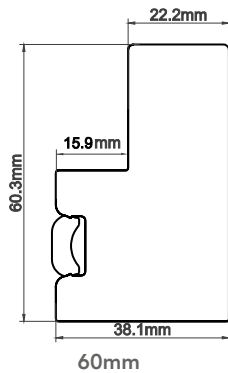

## PLAIN L FRAME

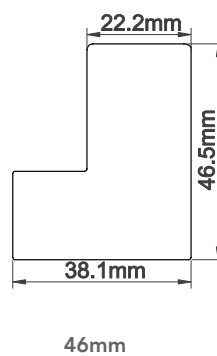

# FRAMING STYLES

## DOUBLE INSERT L FRAME

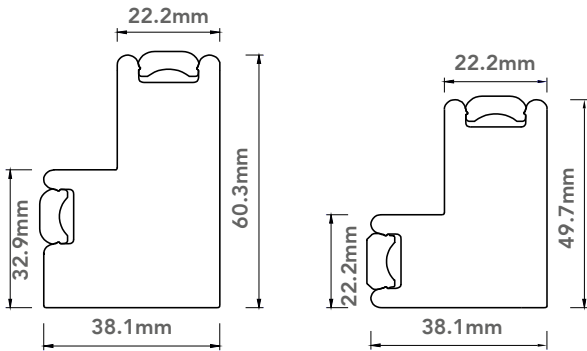

Note: No screw holes will be pre-drilled for Double Insert L Frame, but 76.2mm screws will be supplied loose in the hardware box.

Double Insert L Frame  
50mm

Double Insert L Frame  
60mm

## TIARA Z FRAME

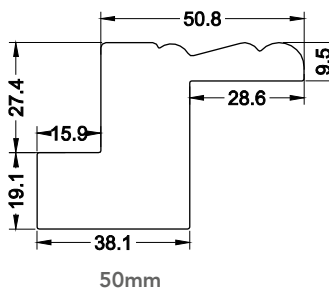

50mm

## TIARA Z SILL PLATE

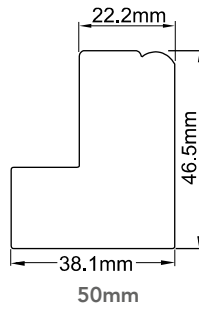

50mm

## CROWN Z FRAME

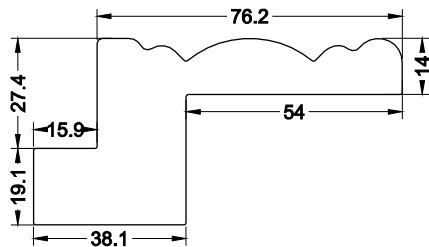

76mm

## MISSION FRAME

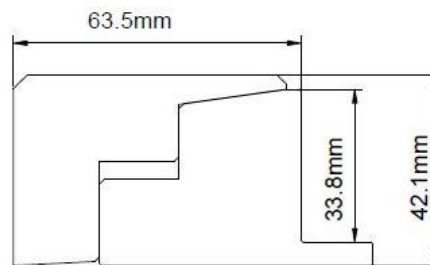

63mm

## CROWN Z SILL PLATE

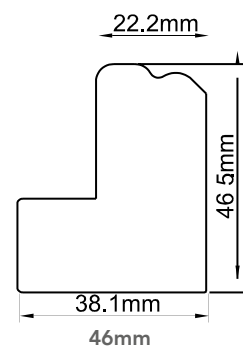

46mm



**BEADED Z**

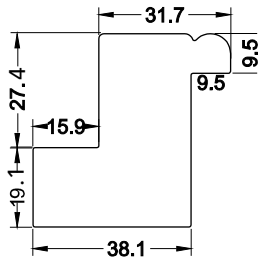

31mm

**BEADED Z SILL PLATE**

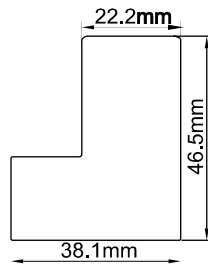

**BULLNOSE Z**

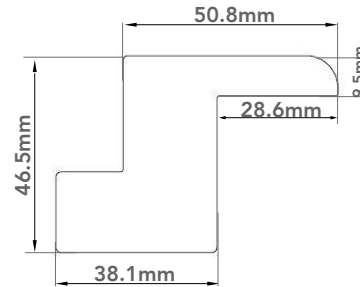

50mm

**BULLNOSE Z**

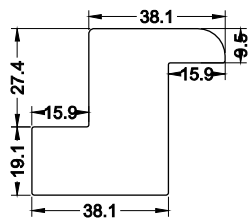

38mm

**BULLNOSE Z SILL PLATE**

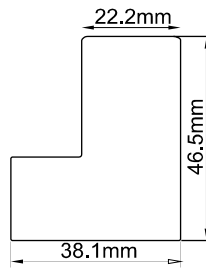

38mm

**BULLNOSE Z DEEP W/INSERT**

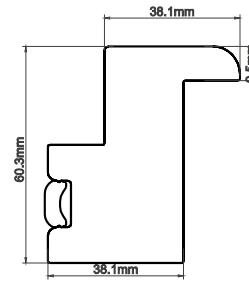

38mm

**RIDGE DECO FRAME**

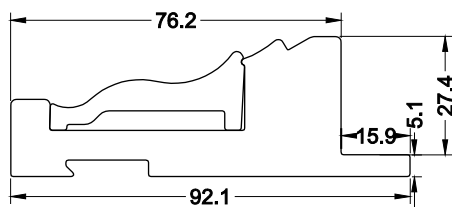

76mm

**RIDGE DECO SILL PLATE**

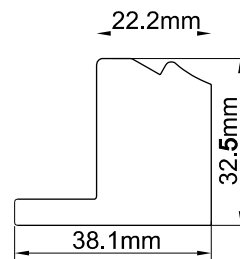

**SERRATE Z FRAME**

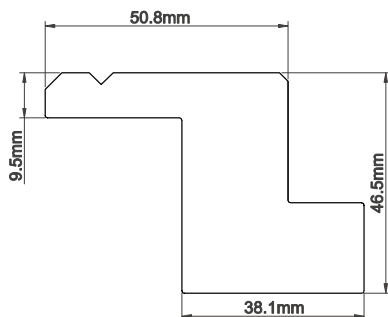

50mm

**SERRATE Z SILL PLATE**

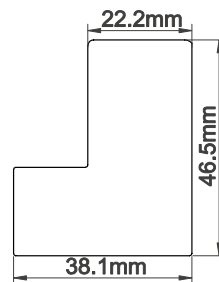

46mm

BACK TO TOP

**CAMBER DECO FRAME**

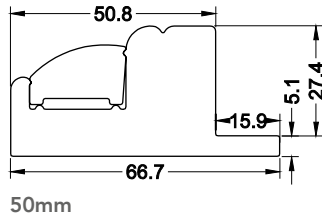

**CAMBER DECO SILL PLATE**

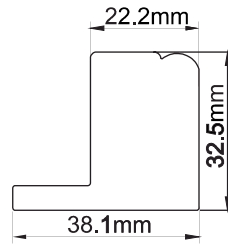

**COVER STRIP\***

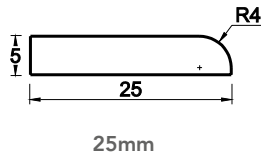

25mm

**COVER STRIP\***

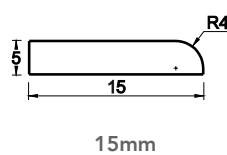

15mm

**VINTAGE HANG STRIP**

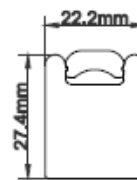

22mm

\* Cover strips are made in wood.

**T-F**

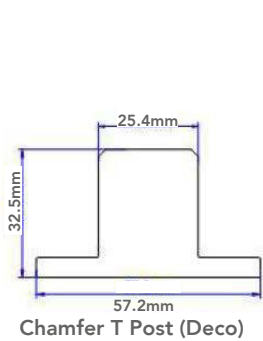

Chamfer T Post (Deco)

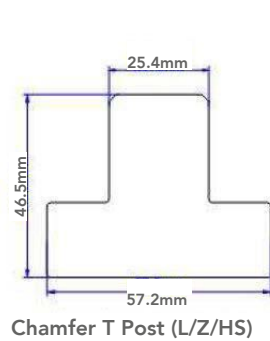

Chamfer T Post (L/Z/HS)

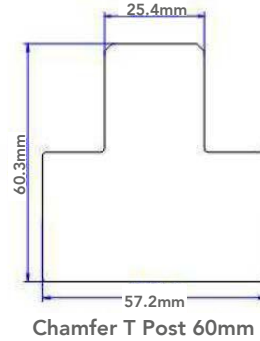

Chamfer T Post 60mm

please note that horizontal sections over 1219mm are not covered by warranty.

**T-POST W/INSERT**

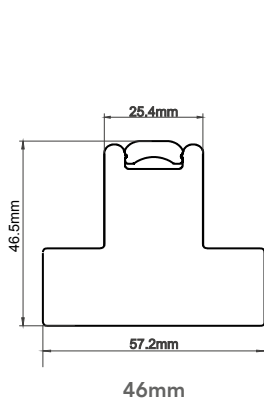

46mm

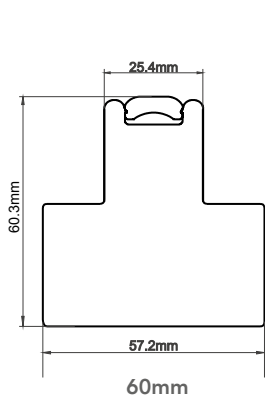

60mm

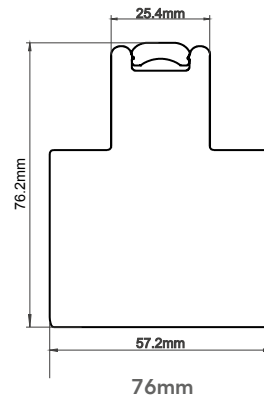

76mm

**NB.** Please note that horizontal T Posts over 1219mm are not covered by warranty.

Insert T-Posts are made of wood.

**CORNER POST**

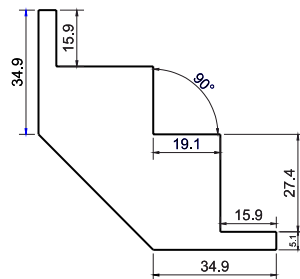

(Deco Frame)

32mm

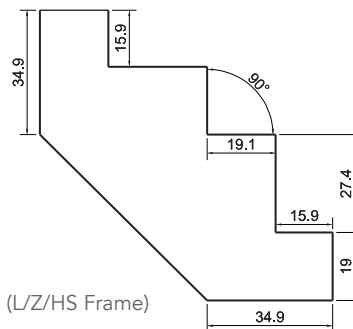

(L/Z/HS Frame)

46mm

**BAY POSTS**

Additional custom angles are also available. Custom angle bay posts cannot have the insert strip.

**135° angle**

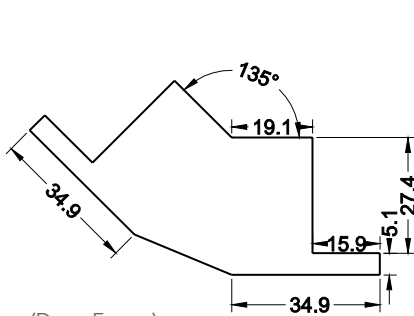

(Deco Frame)

32mm

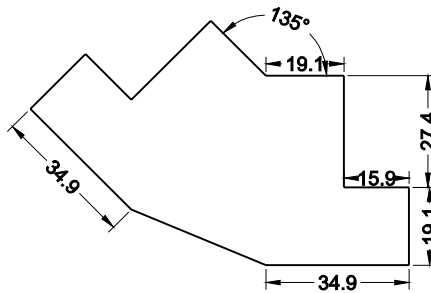

(L/Z/HS Frame)

46mm

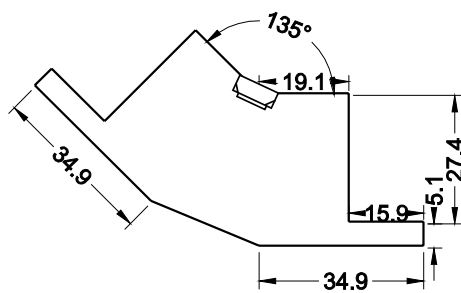

(Deco Frame)

32mm with insert

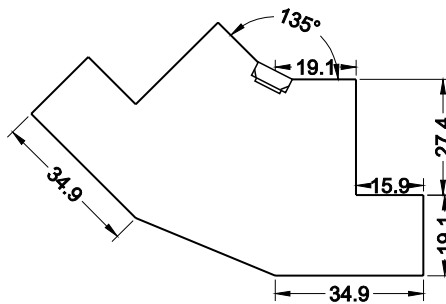

(L/Z/HS Frame)

46mm with insert

**Frames split when the frames length exceed the below limitation.**

When frame lengths (including shutter frames, batten, fascia, header and tracks for track system) exceed the below limitation, then the frames will be split as the below chart describes. Please review the chart for reference.

Shipping Method	Program	Frame Length (L) (mm)
Standard shipping	all programs	3630<L≤7260 (2 sections)/ L>7260 (3 sections)
Airfreight	all programs	3048<L≤6096 (2 sections)/ 6096<L≤9144 (3 sections)

## BATTENS

Battens can be butt-jointed as per the drawings below:



Battens and Panels identification: The PLANTATION SHUTTERS order number will be stamped on the bottom of each panel and one end of each corresponding batten to identify which one belongs to which item.

## Standard sizes:

Stock Battens are available in the following sizes in all materials

### Made of Wood

2.5mm x 27mm  
3mm x 15mm  
3mm x 20mm  
3mm x 30mm  
3mm x 60mm  
5mm x 45mm  
5mm x 63.5mm  
30mm x 40mm  
40mm x 40mm

### Coated with PP

25mm x 30mm  
25mm x 40mm  
5mm x 38mm  
10mm x 38mm  
15mm x 38mm  
20mm x 38mm  
25mm x 38mm  
30mm x 38mm  
35mm x 38mm  
40mm x 38mm

[BACK TO TOP](#)

For batten width less than or equal to 3mm, there will be no warranty if the batten depth is over 100mm; For batten width over 3mm, there will be no warranty if the batten depth is over 200mm.

## Build-out (Extension)

1. For L/Z/Deco/Hang Strip Frame including T-Post, we will pre-attach the build-out of which the thickness is less than 50.8mm (including 50.8mm) by default;
2. For L/Z/Deco/Hang Strip Frame including T-Post, when build-out is over 50.8mm, we will supply build-out loose with holes pre-drilled; also note that for frame not able to pre-drill holes, such as Beaded L Frame, we will supply build-out loose without holes pre-drilled, either.
3. For all frames, we will add build-out per the order form. E.g., if the frame type is 76mm L Frame, and build-out is 10mm, we will use 76mm L Frame added with 10mm build-out instead of changing the frame type to 46.5mm L Frame added with 39.7mm build-out. For bay/corner Post, we will supply build-out in every size pre-attached by default.
4. Extension for Z Frame: If you want the timber to be added to bottom of Z frame like the drawing below on the right, please ALWAYS specify in the special note of the order form, "Add extension to light block section". The DEFAULT EXTENSION will be the left drawing.

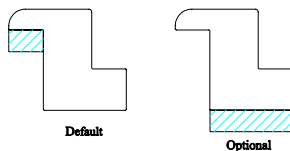

# 4. PANEL DETAILS

BACK TO TOP

## STILES

Beaded

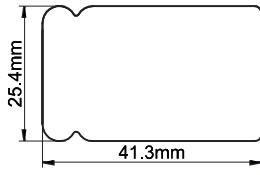

41.3mm Butt Stile

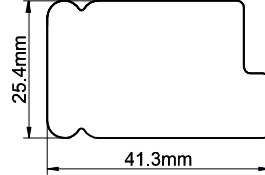

41.3mm Rebate Stile

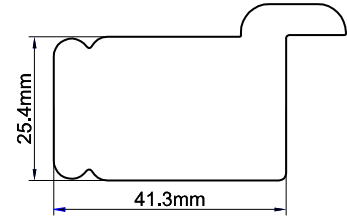

41.3mm D-Mould Stile

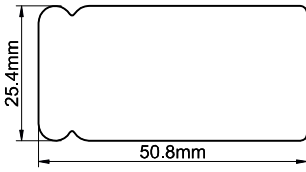

50.8mm Butt Stile

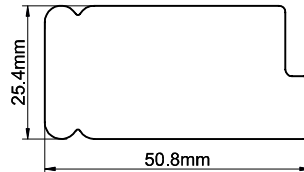

50.8mm Rebate Stile

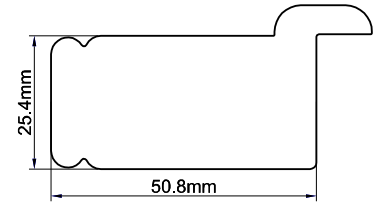

50.8mm D-Mould Stile

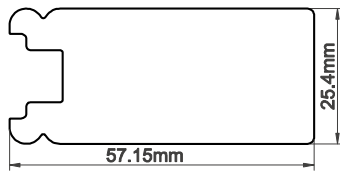

57mm Butt Stile

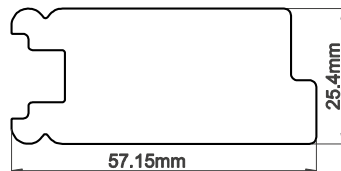

57mm Rebate Stile

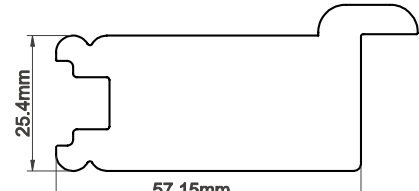

57mm D-Mould Stile

Plain

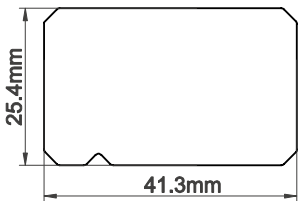

41.3mm Plain Butt Stile

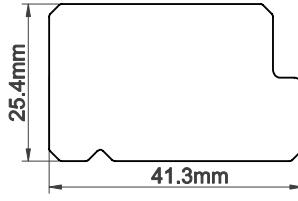

41.3mm Plain Rebate Stile

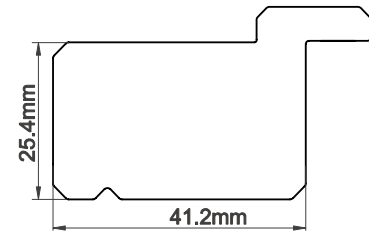

41.3mm Plain D-Mould Stile

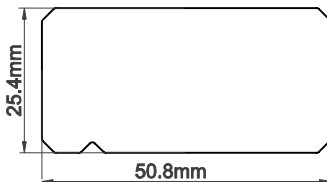

50mm Plain Butt Stile

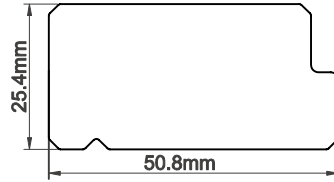

50mm Plain Rebate Stile

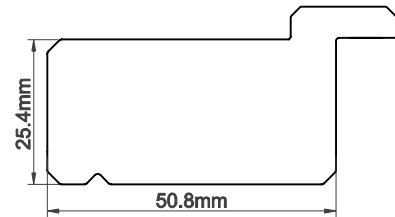

50mm Plain D-Mould Stile

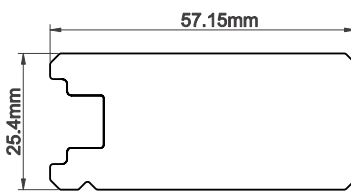

57mm Plain Butt Stile

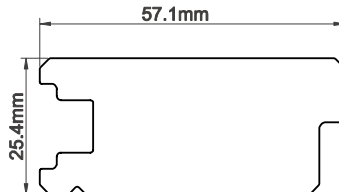

57mm Plain Rebate Stile

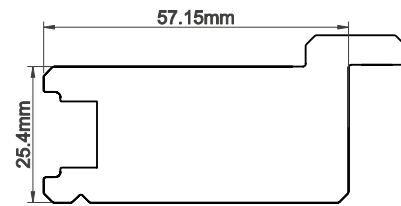

57mm Plain D-Mould Stile

## RAILS

The factory will decide the size, unless otherwise specified in the notes section on order form. The top and bottom rail will be the same size if there is no divider rail. If you need different size rails, please specify.

We suggest ordering shutters for the same customer at the same time, so that the rail sizes will match.

Please note the standard top/bottom rail sizes should be within 69.85mm~165.1mm.

For regular shutters, the step for the rail size is 3.175mm.

## STANDARD MID-RAILS

The standard Mid-Rail size is 76.2mm high. Different mid-rail sizes are not available in Silkwood.

If the panel height is greater than 1981mm one or more mid-rails are required. If the height from the centre of the mid-rail to the top of the top rail or bottom of the bottom rail is 1981mm or more, then another mid-rail is required. Mid-rail positions should be specified at time of ordering. If the order specifies that a mid-rail is not required then all warranties on the order are automatically waived.

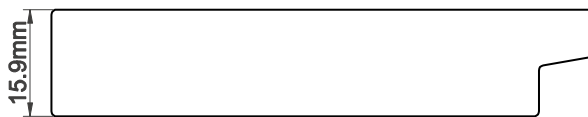

Divider rail:  
Standard divider rail is 76.2mm

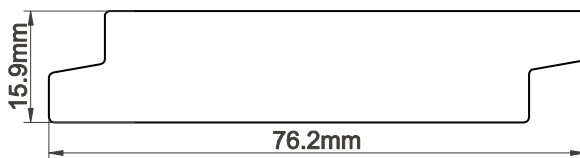

## MID-RAIL continued

Specified rail position is taken from the base of the shutter set to the centre point of the rail, except for solid based which is from the bottom to the top of the mid-rail.

The centre rail can deviate by + or - by the amount of millimetres shown below. If the mid-rail is to be exact with no deviation then this must be noted on the order card under the notes when placing the order.

Louvre Size	Allowable +/- Deviation
47mm	19mm
64mm	25mm
76mm	31mm
89mm	38mm
114mm	51mm

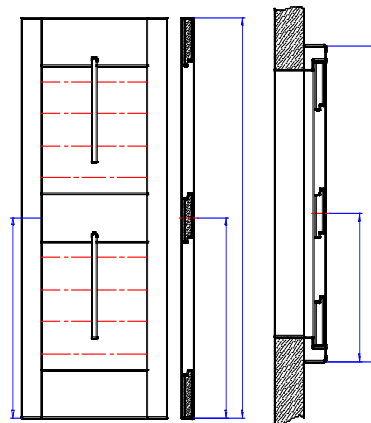

## LOUVRES

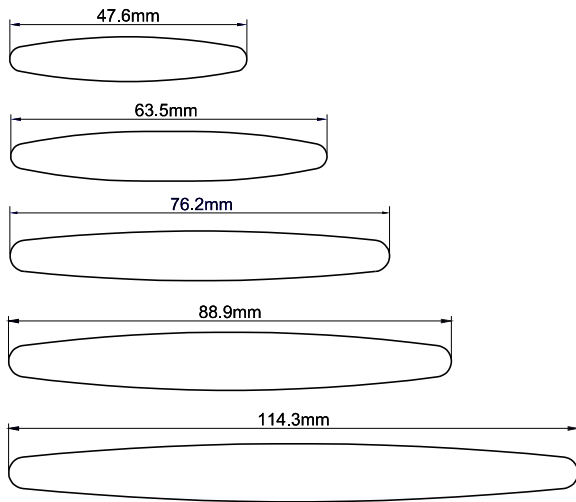

## LOUVRE PIN

Louvre pins are used to ensure louvre tension. In addition a tension screw is inserted into one louvre in the panel. This is the same for all louvre sizes. Access holes are drilled in the in the stile for each panel to allow the tightening or loosening of the tension screw, to adjust the louvre tension. Please note therefore additional holes will be visible in the stiles.

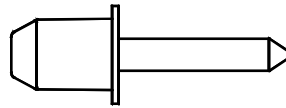

## TILT RODS

### Standard tilt rod

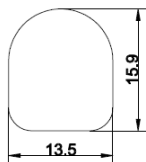

Louvre Size	Maximum number of louvres	Panel Height Range
63mm	24	1289 – 1385mm
76mm	19	1276 – 1372mm
89mm	16	1289 – 1385mm
114mm	12	1289 – 1385mm

### Silent tilt rod

Silent Tilt rods are integrated into the stile and are not visible. Silent tilt rods are available in 63mm, 76mm, 89mm and 114mm louvres. The 47mm does not have this option.

The Silent Tilt rod will automatically be split into 2 parts when the number of louvres connected to the silent tilt rod exceeds the following limits shown in the table opposite.

If the louvre quantity exceeds the above limit, the gear tilt control will be equally split into halves. If the louvre quantity is odd the bottom section will have one more louvres than the top section. If the panel has a divider rail, and the louvre quantity above divider rail or below divider rail exceeds the above limit, split tilt rods are also required.

### OFFSET TILT RODS

Offset tilt rods can be ordered. The standard offset is 25mm from the centre of the tilt rod to the end of louvre on hinge side. If a different offset is required please specify the position from the centre of the tilt rod to the end of the louvre on the hinge side in the short notes on the order form.

The centre of the tilt rod will be 25mm from louvre end on hinge side of the panel. For Fixed panels, the offset tilt rods will be positioned on the left side for all panels. For special shaped panels, the offset tilt rods will be on the higher side of the stile.

### OFFSET TILT ROD FOR MULTI-FOLD SHUTTERS

Multi-fold panels will be made with the tilt rod offset from the centre to enable panels to be folded flat without tilt rods obstructing one another. The standard offset for the tilt rod is 7mm from the centre, i.e. tilt rod will be 7mm to the left of centre for left panels, and 7mm to the right of centre for right panels. Rebates between panels are made right over left. Bi-Fold panels (LR or LLRR) do not require offset tilt rods.

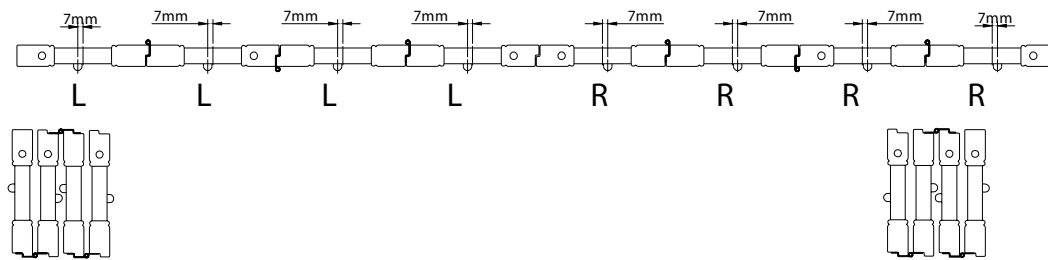

**N.B:** Multi-fold is only available for tracked shutters in Silkwood



# 5. ROOM DARKENING SHUTTER & SHADE

## ROOM DARKENING BLIND OPTION

### 1. Frame option\*:

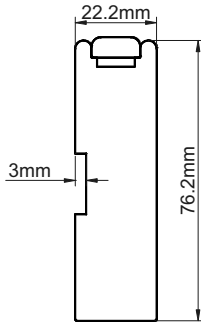

Insert Hang Strip 76mm

\*NOTE: When you order Room Darkening blinds and the frame has a T post please note the defaulted specification below:

- If there is no build out with T post, then the Room Darkening blind will be defaulted to one blind sitting behind the T post.
- If there is build out with T post then the Room Darkening blind will be split according to the T post.

### 2. Frame mounting:

#### Outside Mount

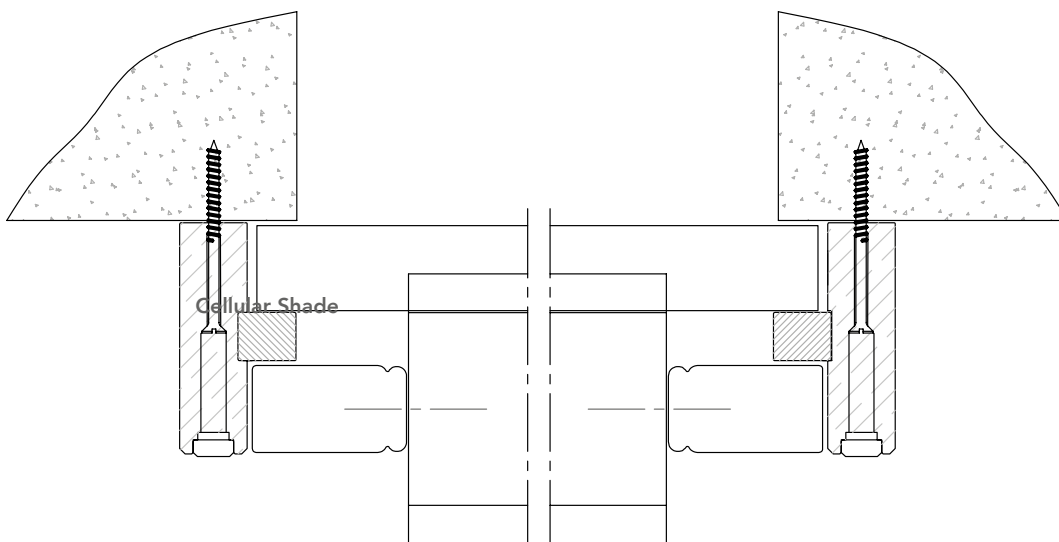

### Inside Mount

Will require a minimum depth clearance 30mm. If it is a bay window inside mount, the top and bottom cover strips will be cut flush on both ends, their length = each section frame outer dimension + 50mm:

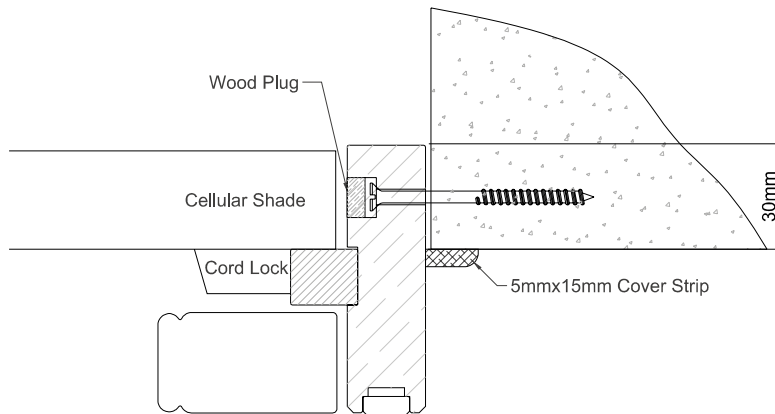

### 3. Number of frames:

3 sided (top, left & right) and 4 sided.

### 4. Available shutters:

All rectangular shutters.

### 5. Available cellular shade:

25mm corded system cellular shade-room darkening.  
 Pull cord is defaulted to the right side.

\* The cord cleat will be on the light block between the shutter and shade.

### 6. Size limit:

	Min. Size	Max. Size	Max. Area
Width	220mm	2500mm	5.5m <sup>2</sup>
Height	250mm	3600mm	5.5m <sup>2</sup>

\* The above chart does not mean that a shade can be ordered in maximum width and maximum height.

\* The shade width and drop must be within the size limitations above and not exceed max area.

**7. If there is a T post, Corner/Bay post, it will be made as below:**

1). If the shade behind is for one whole piece, the post and frame will be jointed as illustrated below: (Take the T post for example).

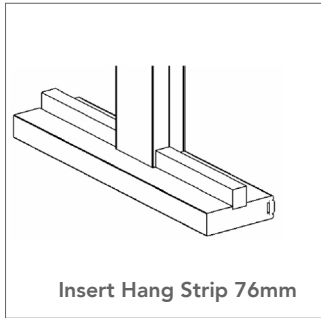

2). If the shade behind is divided into several pieces by the T post, Corner/Bay post, then T post, Corner/Bay post needs additional 29.5mm (hang strip)/33.2mm (LC frame) build out at the back for the standard frame depth. See illustration below:

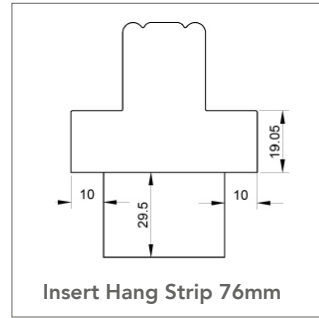

For Corner, Bay post, take LC frame as example:

## ROOM DARKENING BLIND STACKING HEIGHTS

Stacking height schedule: Please note stacking height is just for your information not to the exact height.

254	39	1651	77.8
279.4	39.8	1676.4	78.6
304.8	40.6	1701.8	79.4
330.2	41.4	1727.2	79.8
355.6	42.2	1752.6	80.6
381	43	1778	81.4
406.4	43.8	1803.4	82.2
431.8	44.6	1828.8	83
457.2	45.4	1854.2	83.4
482.6	45.8	1879.6	84.2
508	46.6	1905	85
533.4	47.4	1930.4	85.8
558.8	48.2	1955.8	86.2
584.2	49	1981.2	87
609.6	49	2006.6	87.8
635	49.4	2032	88.6
660.4	50.2	2057.4	89.4
685.8	51	2082.8	89.8
711.2	51.8	2108.2	90.6
736.6	52.6	2133.6	91.4
762	53.4	2159	92.2
787.4	54.2	2184.4	93
812.8	54.6	2209.8	93.4
838.2	55.4	2235.2	94.2
863.6	56.2	2260.6	95
889	57	2286	95.8
914.4	57	2311.4	96.6
939.8	57.8	2336.8	97
965.2	58.6	2362.2	97.8
990.6	59	2387.6	98.6
1016	59.8	2413	99.4
1041.4	60.6	2438.4	100.2
1066.8	61.4	2463.8	100.6
1092.2	62.2	2489.2	101.4
1117.6	62.6	2514.6	102.2
1143	63.4	2540	103
1168.4	64.2	2565.4	103.4
1193.8	65	2590.8	104.2
1219.2	65.8	2616.2	105
1244.6	66.2	2641.6	105.8
1270	67	2667	106.6
1295.4	67.8	2692.4	107
1320.8	68.6	2717.8	107.8
1346.2	69	2743.2	108.6
1371.6	69.8	2768.6	109.4
1397	70.6	2794	110.2
1422.4	71.4	2819.4	110.6
1447.8	72.2	2844.8	111.4
1473.2	72.6	2870.2	112.2
1498.6	73.4	2895.6	113
1524	74.2	2921	113.8
1549.4	75	2946.4	114.2
1574.8	75.8	2971.8	115
1600.2	76.2	2997.2	115.8
1625.6	77	3022.6	116.6

**ROOM DARKENING BLIND  
25MM COLOURS**

[BACK TO TOP](#)

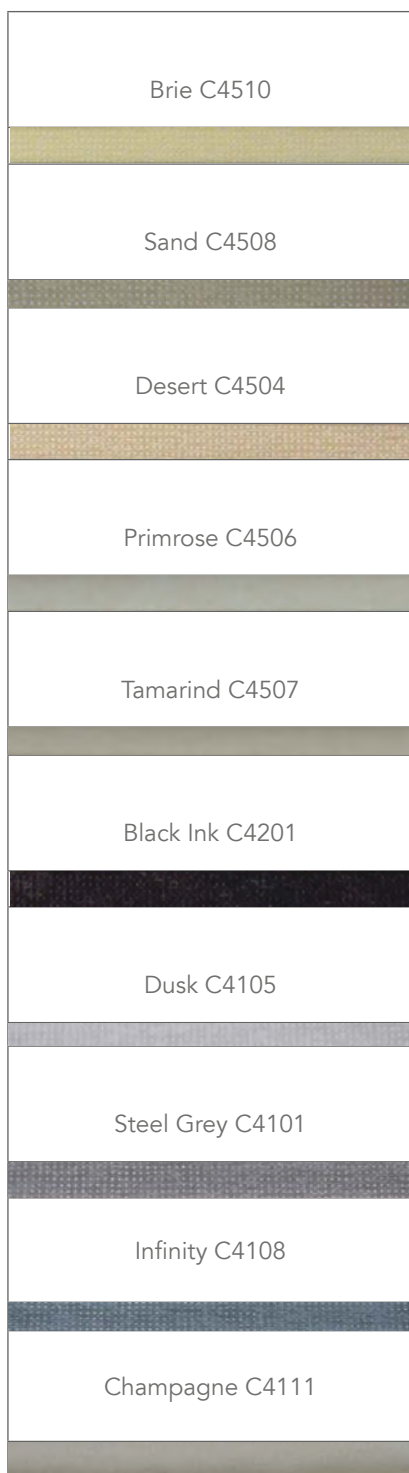

# 6. HARDWARE

[BACK TO TOP](#)

## HARDWARE

### Self-Mortise Hinge:

We will pre-mount the inner piece of hinge on panel when order Overall Panel size and OD of frame, the outer piece and the hinge pin will be included in the hardware box: for OD of frame size, will be attached to the outer piece and hinged to the frame with one screw through the oblong hole.

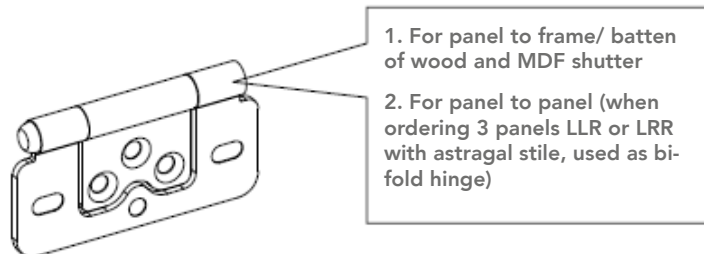

### Offset Hinge:

Used for rebated stiles. All hinges will be pre-mounted on panels.



1. For panel to frame/ batten of wood and MDF shutter
2. For panel to panel (when ordering 3 panels LLR or LRR with astragal stile, used as bi-fold hinge)

### L Hinge:

Used for hang strip inside mount.

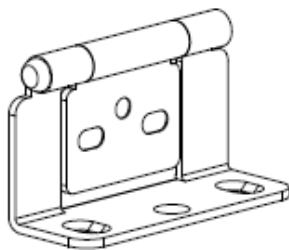

### Hinge Spacer:

To make installing shutters an easier experience, we have included hinge spacers for your convenience. It is very common to find windows that are built square, and depending on the evenness of the mounting surface and how the shutters are installed, the outcome of the installation might be different. The hinge spacer is an easy and reliable tool to help installers overcome such variations during the installation process.

Antique Brass, Bright Brass, Black, Nickel Plated, Stainless Steel (Surcharge), Brushed Nickel Plated (Surcharge), White, Pearl, Bisque, Pure White

### Please Note:

End of hinge to top/bottom of panel is 50.8mm.

### For the Silkwood program

Panel height	No. of hinges
<=1219mm	2
1219mm~1981mm	3
1981mm~2438mm	4
2438mm~3048mm	5
>3048mm	6

## MAGNETS

Round magnets are pre-mounted on the panels and the catch is pre-mounted on the frame when the order is 'OD' type. An 'L' shaped magnet catch is included in the hardware box when ordering 'OP' type.



Catchplate



Magnet

## HANDLE OPTIONS

Handle A and B are available to order in Nickle Plated only. Please specify the handle you require along with the quantity on the notes section of your order card, they will not be pre installed but supplied loose in the hardware box. (Surcharge will apply).



Handle A



Handle B

## HOFFMAN KEYS

These are supplied and are used to join frame corners together.



## L SHAPE MAGNET CATCH

When ordering a 3 sided frame with the gap more than 2.5mm ordering OP OR, an L shape magnet catch will be supplied.



## PANEL FEET

For MDF and MDF+, panel feet will be included in hardware box when ordering OP panels, and mounted on bottom of panels when ordering panels with frame (OD of frame).

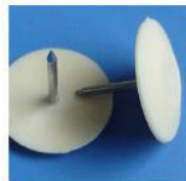

## SIDE MAGNETS

This option is available in the order card and when selected we will add a magnet situated to the side of stile (1). It can be selected where a Left and Right panel meet where there is no lightblock or bottom frame to secure the panels. The magnets will act to keep the panels together (2). Please note that the side magnet is not available if a rebate stile has been selected.



(1) Magnet shown in side of stile



(2) Magnet keeping panels together

### The side magnet can be selected where you have:

- a) Door shutters that require bottom clearance.
- b) Tier on Tier shutters without horizontal T post.  
 The side magnet will be installed on the top of the bottom tier and the bottom of the top tier (3).
- c) Café style shutters with upside down goal post frame (4).
- d) Window that do not have a light block or bottom frame (5).

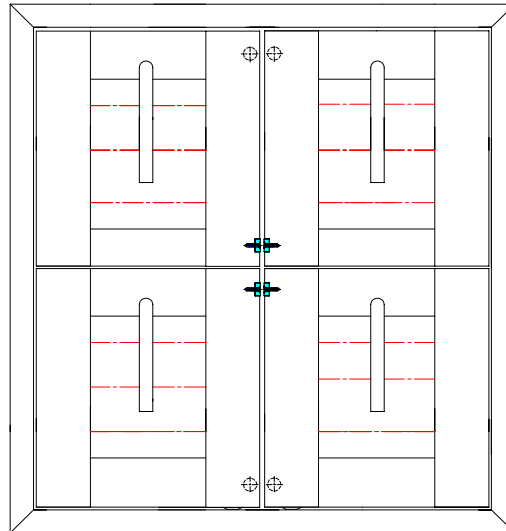

(3) Double Hung shutter without horizontal T post

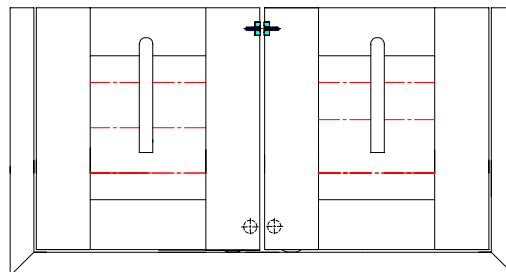

(4) Café Shutter

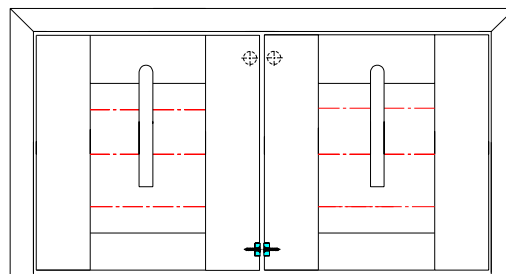

(5) No frame or light block on either top or bottom



## BOLT & RING PULL



### 1. Barrel Bolt

Can be used for hinged shutter and Bi-fold track shutter to fit for panels. Based on the size of the bolt, 41.3mm stile cannot be used for this product.

### 2. Ring Pull

Can be used for hinged shutter and track shutter. Based on the size of the ring pull, 41.3mm stile cannot be used for this product. The location of the ring pull, refer to the bolt location.

## RING PULL & BARREL BOLT

LL

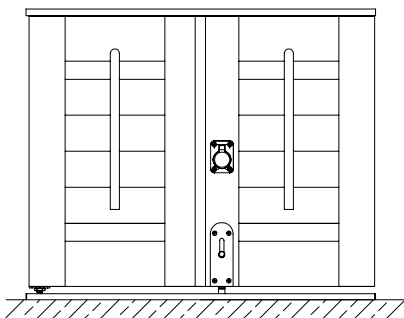

RR

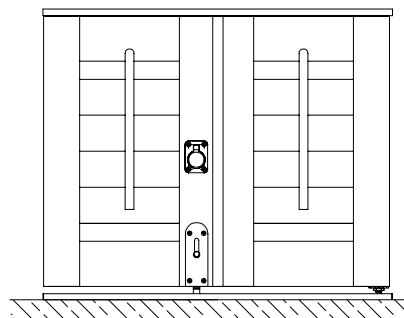

LLL

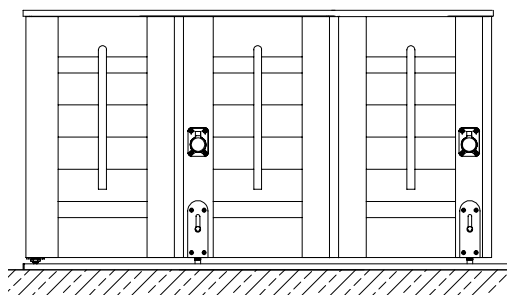

RRR

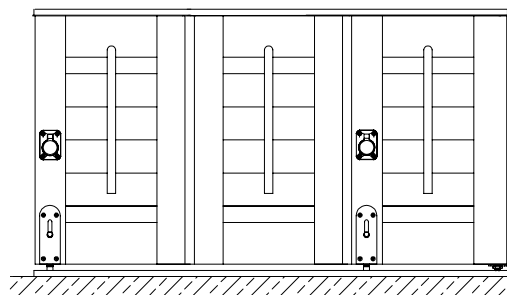

LLRR

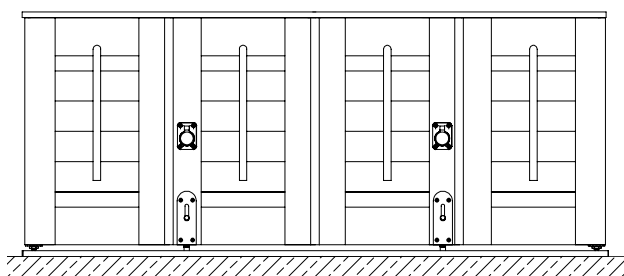

LLL

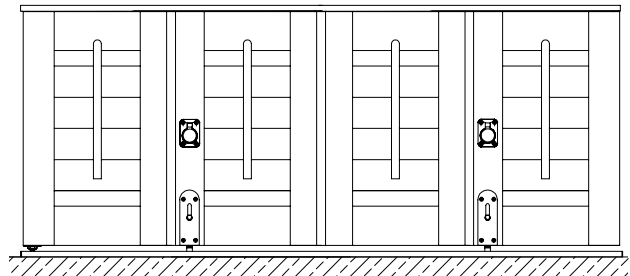

## RING PULL & BARREL BOLT Cont.

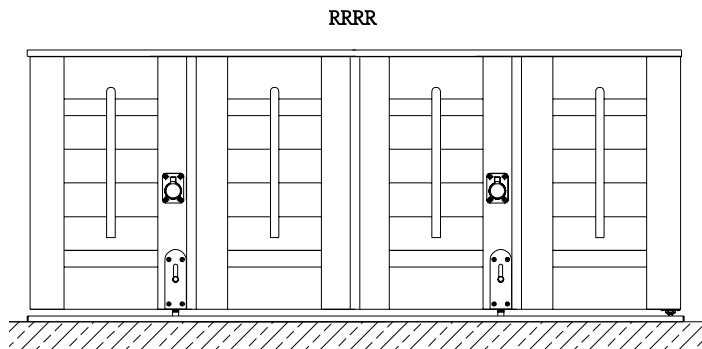

The bolt location for both track system shutters and regular shutters would be the same. The general principle is that the bolt position will avoid the stile which will install the spring-loaded guide at bottom (same stile as the Wheel carrier).

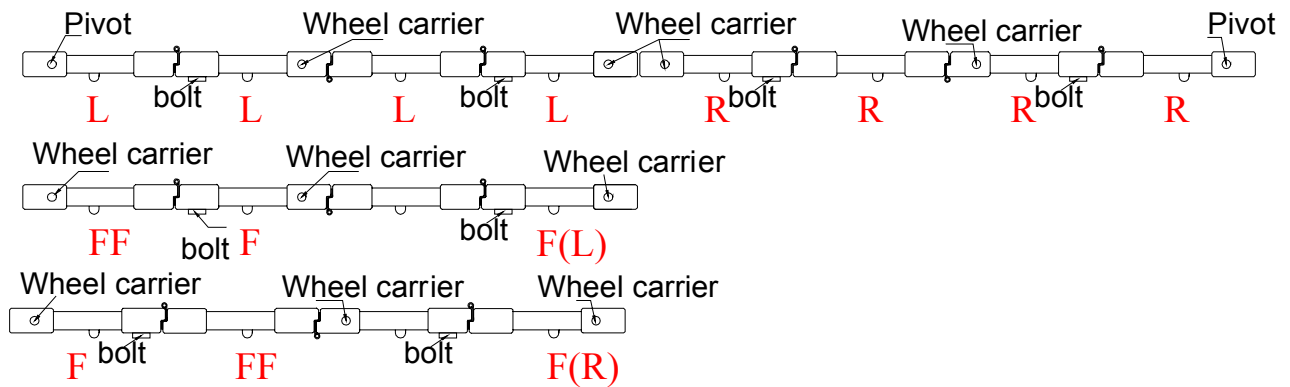

**Ring pull:** for easy opening and closing (Not available for 1.625" /47mm Stile)

**Ring Pull and Barrel Bolt:** Customer needs to specify ring pull location on the order form. Ring pull location principle for Floating Panels: (same as the location of 90° Bifold Track)

1. When floating panel config is in pairs, it will be split into halves, the left will be for LL and the right will be for RR. So the ring pull location for FF/FF, FF/FF/FF/FF will be same as that of panel config as LL/RR, LL/LL/RR/RR.
2. When floating panel config is FF, the ring pull location will be same as that of panel config LL.
3. When floating panel config is singular, it will be split into 3 sections, the left and mid sections are for LL and the right section is for RR. So the ring pull location for FF/FF/FF, FF/FF/FF/FF/FF will be same as that of LL/LL/RR, LL/LL/LL/RR/RR.

Please note the ring pull finish will match with the hinge finish.

Please see the matching chart below:

Hinge	Pure White	White	Bisque	Pearl	Black	Nickel	Brushed Nickel	Antique Brass	Bright Brass	Stainless Steel
Ring Pull	White	White	Bisque	Pearl	Black	Brushed	Brushed Nickel	Antique Brass	Bright Brass	Brushed Nickel

Position: For different panel configuration, please refer to the location of bolt to show on which stile the pull will be fixed.

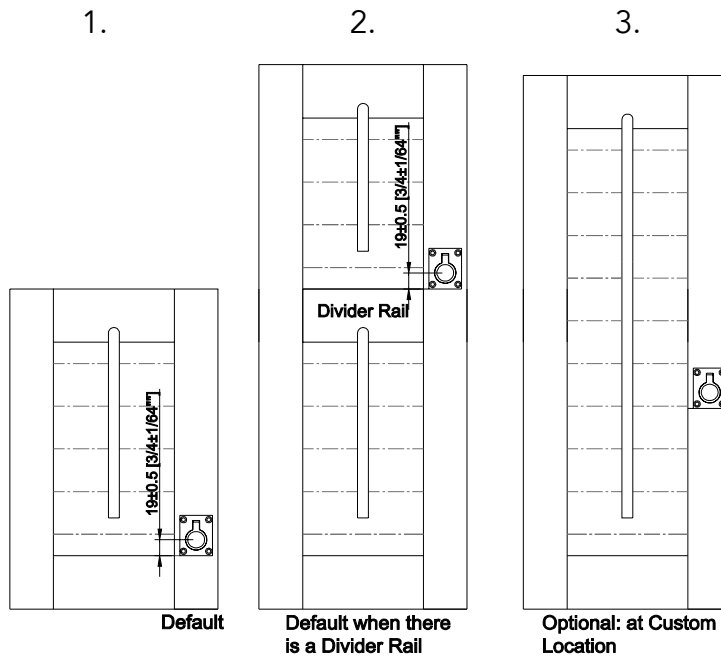

**Position:**

1. Above Bottom Rail (Default)
2. Above 1st Divider Rail (Default when there are Divider Rails)
3. Custom Location

If both bolt & ring pull are specified, the distance between them is 2 3/4" (70mm), and the ring pull location is 6 3/4" (170mm) from the bottom of panel.

When there is no mid rail, ring pull will be just on the top of Bolt (2 3/4" /70mm above bolt) as default location; if there are mid rails, bottom of ring pull lines up with top of the 1st mid rail as default location.

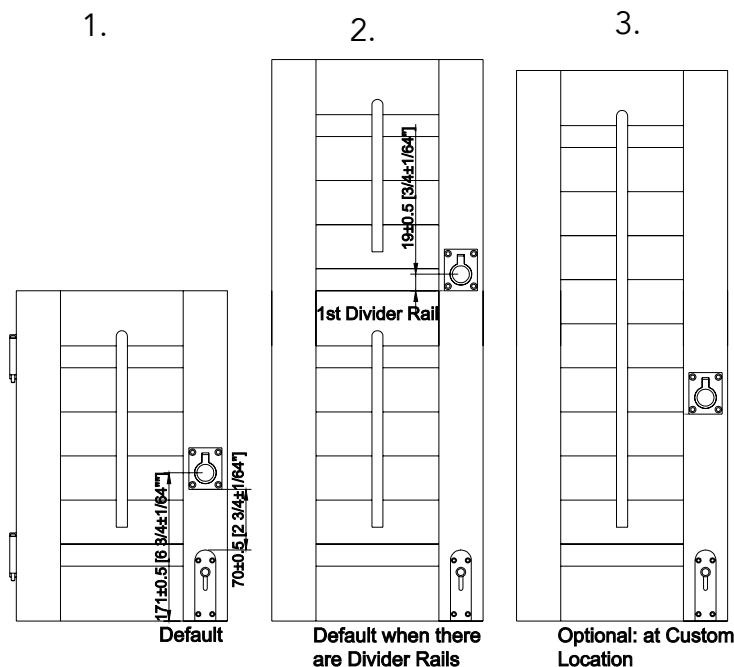

**Position:**

1. 2 3/4" (70mm) Above bolt (Default when both Ring Pull and bolt are specified)
2. Above 1st Divider Rail (Default when there are Divider Rails)
3. Custom Location

**Measurements:**

Window size: Measure from the bottom of the window to the centre of the ring pull

Max frame-to-frame: Measure from the bottom of the frame to the centre of the ring pull

## PANEL CONFIGURATIONS

If you order shutters in OVERALL PANEL SIZE & OD OF FRAME, panel configuration is required. Please specify if the stile type required is Rebate or D-Mould. Please note Silkwood is supplied with a flat stile.

### 1 panel: L/R

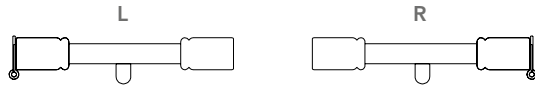

### 2 panels: LL/RR/LR

#### A) Rebate stile

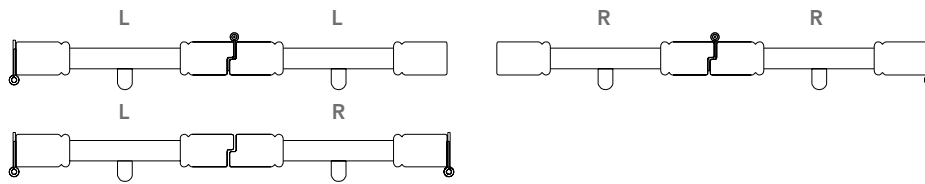

#### B) D-Mould stile

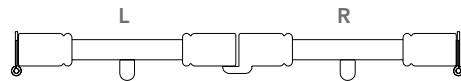

### 3 panels: LLR/LRR

#### A) Rebate stile

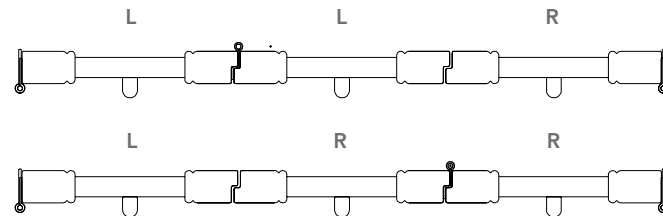

#### B) D-Mould stile

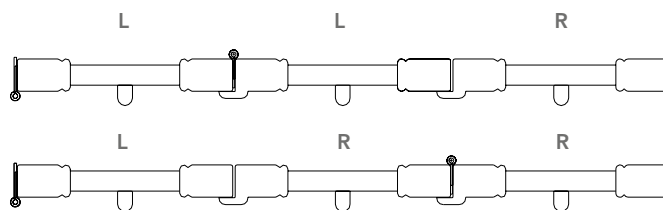

**4 panels: LLRR**

A) Rebate stile

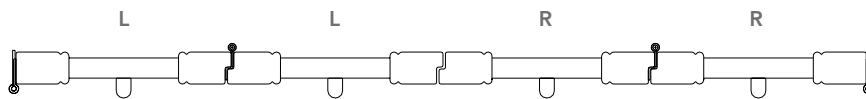

B) D-Mould stile

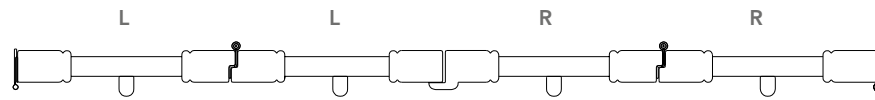

**Offset tilt rod for multi-fold shutters**

For multi-fold panels, we will place the tilt rod offset from the centre. By doing so, panels can be folded flat without tilt rods obstructing each other. The standard offset for the tilt rod is 7mm from the centre, i.e. tilt rod will be 7mm to the left from the centre for the left panels, and 7mm to the right from the centre for the right panels. Besides, the Rebate is made with right panels over left ones for both the panels folded to left and to right.

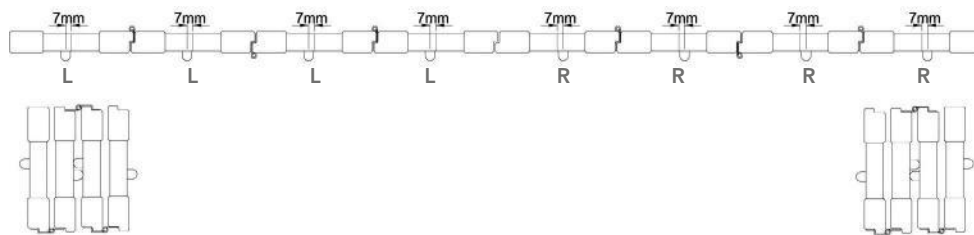

\* For 2 panels (LL/RR) and 4 panels configuration (LLRR), there is no need to offset the tilt rod.

## PANEL SIZE LIMITATIONS

### Panel structure

The PLANTATION SHUTTERS shutter panel is made up of several parts. To help you understand the panel construction please see photograph.

**MOUSE HOLE**

**STILE**

**TILT ROD**

**LOUVRE**

**RAIL**



Louvre Size	Width			Height		
	Minimum	Maximum		Minimum	Maximum	Mid rail
		Single hung	Bi-fold hinged shutter/ Multi-fold with Top and Bottom track			Required if
47mm	152mm	610mm	610mm	250mm	3000mm	H>1981mm
63mm	152mm	915mm		250mm	3000mm	H>1981mm
76mm	152mm	915mm		250mm	3000mm	H>1981mm
89mm	152mm	915mm		250mm	3000mm	H>1981mm
114mm	152mm	915mm		250mm	3000mm	H>1981mm

**NB:** Where the panel size limits above are exceeded, warranty on the order line is waived automatically.

**NB:** When a single hung panel width is less than 228.6mm and used with the following frames: Deco, L, Z and Hang Strip, the stile opposite to the hinge will be rebated.

If panel height is over 1981mm, a Mid Rail is required and if the panel has a Mid Rail but the height from the centre of the Mid Rail to the top of the top rail or to the bottom of bottom rail is still over 1981mm, another Mid Rail will be required.

If you do not specify the Mid Rail location, the order will be held to confirm if a Mid Rail is required. However, if you specify no Mid Rail, you will waive your warranty and manufacture will proceed as per your instructions.

### Shutter used for door without bottom support:

In situations where shutters are used for door applications, which do not have any support underneath the panels, the customers must inform PLANTATION SHUTTERS when placing this type of order. (See the following specs for Shutters used in Door applications)

Please note:

- (1) The factory will add extra hinges to support the panels.
- (2) Bigger and Stronger Top and Bottom rails will be added to reduce the probability of the panels sagging and increase shutter intensity.
- (3) If customers fail to notify PLANTATION SHUTTERS that the shutter will be used in door applications, the customers will be responsible for the cost of the any re-order that is submitted.

Please see the following chart for details.

L,R,LR	LL, RR, LLRR
Manufactured with warranty waived	Must order it with track, we will not process it even with warranty waived

## PANEL WEIGHT

Panel Weight		
Material	Louvre size	Weight (kg)/m <sup>2</sup> *
Silkwood	47mm	6.24
	63.5 mm	8.15
	76.2 mm	8.16
	88.9 mm	8.18
	114.3 mm	TBC

\* Average Weight

## FIXED LOUVRE OPTIONS

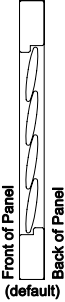
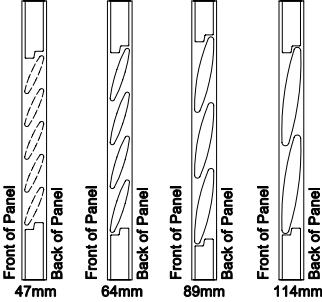
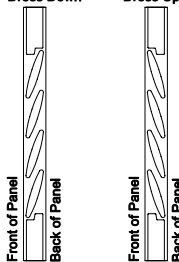
	Fixed Closed Position	Fixed Open Position
<p>Available in two positions: closed or open at angle. Available in 4 louvre sizes, 47mm, 63mm, 89mm, 114mm</p>	 <p>Front of Panel Back of Panel (default)</p>	 <p>Front of Panel Back of Panel 47mm</p> <p>Front of Panel Back of Panel 64mm</p> <p>Front of Panel Back of Panel 89mm</p> <p>Front of Panel Back of Panel 114mm</p>
<p>The standard default orientation for Fixed louvres is Closed 'Dress Down' with the bottom edge of louvres to the front of the panel. 'Dress Up' option is also available if specified on the order form.</p> <p><b>NB.</b> Note that normal orientation for <i>adjustable louvres</i> when closed is in the 'Dress Up' state.</p>	 <p>Dress Down</p> <p>Front of Panel Back of Panel</p> <p>Dress Up</p> <p>Front of Panel Back of Panel</p>	

# 7. SIZING AND MEASURING

## ORDER SIZE DEFINITION

### Overall Panel size (OP):

The size given is the overall panel size. The width does not include the hinge space from panel to batten on the left & right side, but does include the gap between panels, the standard gap is 2mm between panels and we will calculate the single panel width based on this measurement (see diagram below). The height given must be net panel height. We will pre-mount the hinges and the magnets and include panel feet and L shape magnet catches in a hardware box.

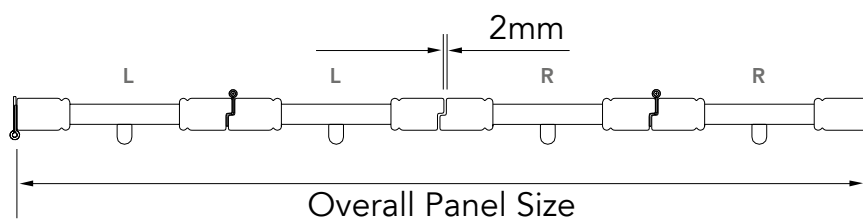

### OD of frame:

Size given is "Outside Dimension" of the shutter; we will pre-mount the hinges and the magnets, and will include all the necessary hardware in a hardware box. The stiles can be Rebate and D-Mould stile, please specify on the order form.



Camber Deco Frame 50mm: Can only be ordered as outside mount, the size given must be OD of frame size.

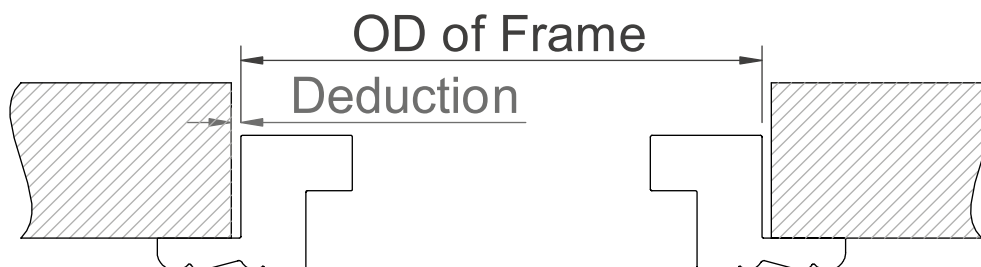

"Z" frame: Can only be ordered as inside mount, the size given must be OD of frame size. (Backside of Z frame, refer the drawings).



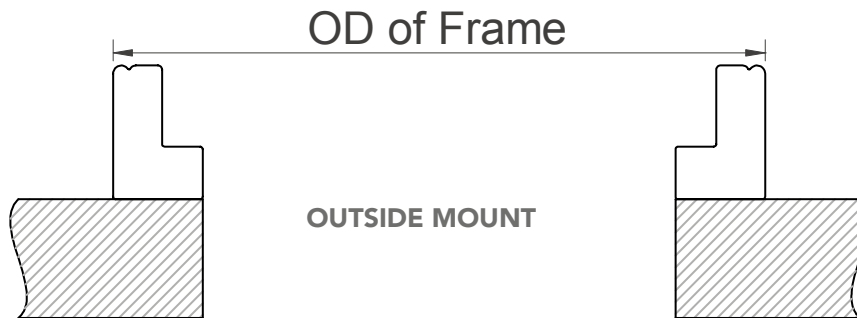
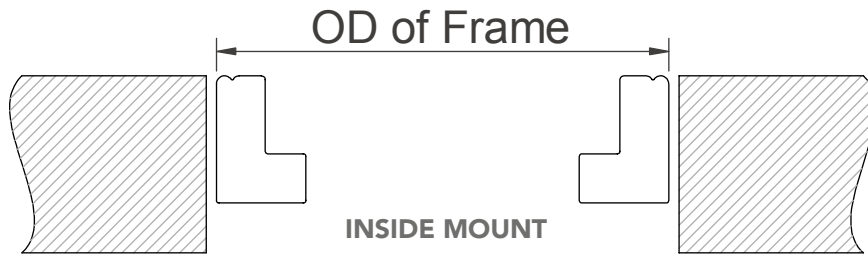

"L" frame: Can be ordered as inside mount and outside mount, size given must be OD of frame size.

## TOLERANCES

**Width:** The width of the panel can be plus or minus 1.6mm from the order width.

**Height:** The height of the panels can be plus or minus 1.6mm from the order height.

**Mid Rail location:** Mid Rail location may be off by half a louvre space. Measure from bottom of bottom frame to centre of Mid Rail if order OD of frame, and from bottom of panel to centre of Mid Rail if order net panel size or overall panel size.

For 47mm louvre can be off by +/-19mm.

For 63mm louvre can be off by +/-25mm.

For 76mm louvre can be off by +/-31mm.

For 89mm louvre can be off by +/-38mm.

For 114mm louvre can be off by +/-51mm.

## MOUNTING TYPE

**Café style shutter:** Please specify on the order form if the shutter is a café style. We will finish the top of the panels and one end of the battens.

If a café shutter is required with a 3 sided frame, it should be 3 sides inverted.

**Tier on Tier:** The standard gap between the top tier and bottom tier is 2.5mm.

**Full height:** Regular shutters running the full height of a window.

Plantation Shutters Ltd  
Unit 10 River Reach Business Park  
1 Gartons Way  
Battersea  
London  
SW11 3SX  
Tel: 020 8871 9222

[www.plantation-shutters.co.uk](http://www.plantation-shutters.co.uk)

**Emma - Sales Manager**  
[emma@plantation-shutters.co.uk](mailto:emma@plantation-shutters.co.uk)