

ULTRA TECHNICAL SPECIFICATIONS



ULTRA SPECIFICATIONS CONTENTS

To go to required section click coloured headings below

Section 1			
Introduction	3	Battens	
Specifications	4	Build-out	
Colours	5	Section 4	
		Panel details	13
Section 2		Stile	
Installation Styles	7	Rails	
Full Height		Louvres	14
Cafe Style		Louvre pin	
Tier on Tier		Tilt Rods	
Tracked Shutters		Standard tilt rod	
Unsupported Shutters		Silent tilt rod	
Solid Panels	8	Specified tilt location	
Special Shapes		Offset tilt rod	15
		Offset tilt rod for Multi-fold Shutters	
Section 3		Section 6	
Framing elements	9	Hardware	17
Frame styles		Bolts & Ring Pulls	19
Beaded L			
Insert L		Section 7	
Crown Z		Sizing & Measuring	25
Deep Bullnose Z		Order Size Definition	
Bullnose	10	Overall Panel size (OP)	
Deep Plain L		Overall Dimension of frame (OD)	
Tiara Z		Tolerances	26
Serrate		Mounting Type	
Plain L			
Beaded Z		Section 8	
Camber Deco		Contact Info	27
Ridge Deco			
Mission			
Hang Strip			
Bay Posts	11		
Deco			
L/Z			
Corner Posts			
Deco			
L/Z			
T-Posts			
Deco			
L/Z			
Coverstrip	12		

1. ULTRA INTRODUCTION

Ultrawood is manufactured from the highest grade ayous when painted and the finest white teak when stained.

Aesthetics:

PLANTATION SHUTTERS's Ultrawood range is crafted from the finest quality timber. It is manufactured from the highest grade ayous when painted and the beautiful tight grain of white teak when stained.

This distinctive new product features thick robust frames to accommodate an optional hidden hinge. The fully adjustable hinge creates a sleek and modern design, with elegant contours and clean doors. The frames and louvres are proportionate in size, producing a visually pleasing finish.

Frames:

Large range of frames available.

Stiles:

Please note the stiles are manufactured in a plain finish only. The stile has a depth of 31.8mm, and our engineered stiles are reinforced by using multiple layers of wood bonded together to ensure that the panel does not twist or warp.

Louvres:

Ultrawood is available in 47mm, 64mm, 76mm, 89mm and 114mm elliptical louvres.

Special Shapes:

Linear and curved special shapes are available.

Colour palette:

There are a total of 50 contemporary colours, 23 paint and 27 stain. Custom colour is available.

ULTRA SPECIFICATIONS

PANEL SIZE LIMITATIONS

Panel Configuration		Louvre	Minimum	Maximum	
Width	Single Panel	47mm	152.4mm (for 50.8mm stile)	762mm	
		63mm & 76mm		914.4mm	
		89mm & 114mm		1219.2mm	
	Bi-fold Panel	Bi-fold hinged shutter	All louvres	165.1mm (for 57mm stile)	660.4mm
		Bi-fold track			508mm
		Multi-fold track (up to four panels)			508mm
Height	Single Panel Height	Adjustable hidden hinge	All Louvres	304.8mm	3657mm
		Self Mortise Hinge			
	Divider Rail	2133.6mm < panel height <3352.8mm one divider rail 3352.8mm < panel height <3657mm two divider rails			

* If single panel size exceeds the limitation above, the warranty will be waived automaticall .

If single panel width is less than 230mm, to make sure that the panel can open without hitting the frame or T-post, the factory will automatically change the stile on non-hinged side to a rebate or whatever stile type is required (not for panel only).

Divider rail is required when panel height exceeds 2133.6mm, and the second divider rail is required if the panel height exceeds 3352.8mm or if the panel has a divider rail but the height from the centre of divider rail to the top of the rail or to the bottom rail is still over 2133.6mm. Otherwise there will be no warranty.

If you do not specify the divider rail location, we will hold the order to confirm if a divider rail is required. But if you have specified no divider rail, we will regard this as you have waived your warranty.

SPECIFICATIONS













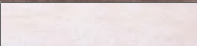
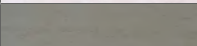

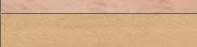





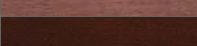

Material	Painted: Hardwood ayous, basswood + poplar LVL Stain: White teak
Average Panel Weight per sqm	8.68kg
Paint Colours	23
Stain Colours	27
Custom Colours available	✓
Louvre sizes	47mm 63mm 76mm 89mm 114mm
Max single panel width	762mm : 47mm 914mm : 63mm 914mm : 76mm 1219mm : 89mm 1219mm : 114mm
Max multi panels width	508mm : REST
Max number of panels hinged together	2 frame (4 track)
Max and min panel heights	3657mm 304mm
Solid Panels available	✓ N.B Shaker stain only
Special shapes	✓
Custom Bay Post angles	✓
Stile Type	Chamfer 50.8mm and 57.15mm stiles
Fixed Louvres	✓

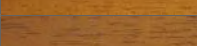
COLOUR OPTIONS

Ultrawood is available in 50 colours: 23 painted and 27 stained options Custom colour is also available with a surcharge.

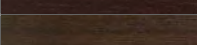
ULTRAWOOD PAINT OPTIONS (23 COLOURS)					
Colour ID	Colour Name		Hinge Colour (Default)	Optional Adjustable Hidden Hinge (Default)	Top Track Colour (Default)
001	Pure White		Pure White	Silver	White
002	Extra White		White		
003	Silk White				
004	Bright White				
006	Pearl		Pearl		
007	Ivory Lace		Bisque		
009	Creamy		Pearl		
011	Cameo		Bisque		
012	Crisp Linen		Crisp Linen		
013	Bisque		Bisque		
014	Alabaster				
016	Butter		Crisp Linen		
019	String		String		
030	Moondust		Sea Mist		
032	Sea Mist				
048	Chai		Nickel Plated		
049	Stone Grey		Stone Grey		
051	Brown Grey		Brown Grey		
053	Clay		Nickel Plated		
066	Winchester White 2010		Pearl	Silver	White
072	Mattingley 2671		Sea Mist		Anodised Silver
080	Taupe Grey		Taupe Grey		
836	Classic Black (surcharge)		Black	Black	

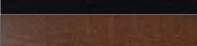
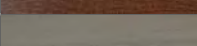
Due to the nature of material manufacturing, colours may vary slightly between dye lots. Please order shutters for the same home at the same time. Slight variations may also occur between the finished products and the colour swatches you use.

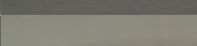
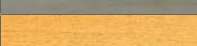
ULTRAWOOD STAIN COLOURS (27 COLOURS)					
Colour Code	Shutter Colour		Hinge Colour (Default)	Optional Adjustable Hidden Hinge (Default)	Optional Adjustable Hidden Hinge (Default)
108	Rustic Grey		Nickel Plated	Champagne	Anodised Silver
109	Weathered Teak				
110	Limed White		White	Silver	White
111	Pebble				
114	Taupe		Nickel Plated	Silver	Nickel Plated
202	Golden Oak		Antique Brass	Champagne	Coffee
204	Oak Mantel				
205	Goldenrod				
211	Cherry				
212	Dark Teak				
215	Cordovan				
219	Mahogany				
220	New Ebony			Black	
221	Black Walnut				
227	Red Oak			Champagne	
229	Rich Walnut				
230	Old Teak				
232	Red Mahogany				
233	Dark Mahogany				
237	Wenge				
242	Auburn				
246	Matte Black (surcharge)		Black	Black	Anodised Silver
252	Toffee		Antique Brass	Champagne	Coffee
254	Driftwood		Nickel Plated	Silver	Anodised Silver
255	Silver Grey				
256	Mist		White		White
862	French Oak		Antique Brass	Champagne	Coffee

Due to the nature of material manufacturing, colours may vary slightly between dye lots. Please order shutters for the same home at the same time. Slight variations may also occur between the finished products and the colour swatches you use.

2. INSTALLATION STYLES



FULL HEIGHT

Shutter covering the full height of aperture.



TRACKED SHUTTERS

Bi-Fold

Shutters suspended from a top track hinged together in a bi-fold configuration to allow them to be folded back to the end of the track at 90° or 180°. Suitable for use with patio doors, wardrobes or as a room divider. May be specified and fitted with or without side frames.

By-Pass

Shutters suspended from a top track. Panels slide behind or in front of one another to open or close. Suitable for use with patio doors, room dividers and wardrobes. May be specified and fitted with or without side frames.

* Refer to the separate track specifications for further details.



CAFE STYLE

Shutter covering only the lower portion of aperture providing privacy and light control but leaving the top portion un-shuttered to maximise light, where privacy is not required.



SHUTTERS USED AS DOORS

In situations where shutters will be used for a door application, the customer must inform PLANTATION SHUTTERS when placing the order.



ROOF SHUTTERS

Shutters to be installed in an angled or horizontal window. Please refer to Pearlwood specifications. We do not cover roof shutters under warranty in Ultrawood.

Panel Configuration

L, R, LR	LL, RR, LLRR
	Only available with a tracked installation.
Manufactured with warranty waived	Not covered by warranty.

(except invisible hinge)

Please note:

1. The factory will add extra hinges to support the panels
2. The factory will add a larger and stronger top and bottom rail. This will reduce the risk of panels sagging.

N.B Customers will be responsible for any EDR re-order where there has been a failure to notify PLANTATION SHUTTERS that the original shutter order was for a door application.



TIER ON TIER

Shutter is split into two halves so the top and bottom panels can be independently operated / opened fully. The standard gap between top tier and bottom tier is 2.5mm. For tier-on-tier shutters only or less bi-fold panels are within warranty.



SOLID PANELS

Solid panels are available in the following materials.

Material	Solid panels
Ultrawood	Solid Raised, Solid Shaker* Solid Based

*Not available with a painted finish.



SPECIAL SHAPES

Special shapes including, Fan top (radiating semi-circle), Arched, Angled, Horizontal or Radiating Circles, Octagon, Hexagon and Oval are available.

CAD drawings are produced for all shapes for approval prior to production. Please double check every dimension on the CAD to ensure accuracy. They are not provided for rectangular shutters.

Templates or precise technical drawings are always required for:

- inside mount special shapes
- imperfect arches
- when the shutter covers window mouldings
- oval shapes
- frames requiring cut-outs

They are not required for rectangular shutters.

NB. The insert frame comes with a removable insert. However, when used on a curved special shape it is not possible to make the curved frame with the removable insert so a fixed version of the frame is used instead. Where the special shape involves straight sections and curved frame sections (e.g. and Arched shutter) it is possible to specify a removable insert on the straight sections and combine these with the fixed inserts on the curved sections. However, the junction where the insert meets the fixed frame may be unattractive as a result so this option is not recommended. If you wish to specify inserts on the straight section, please indicate this in the short notes on the order.

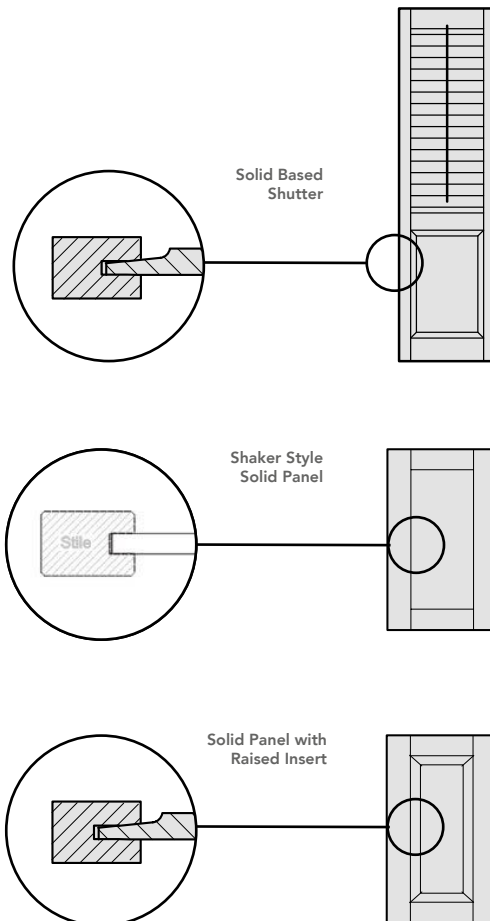

3. FRAMING STYLES

BEADED L FRAME

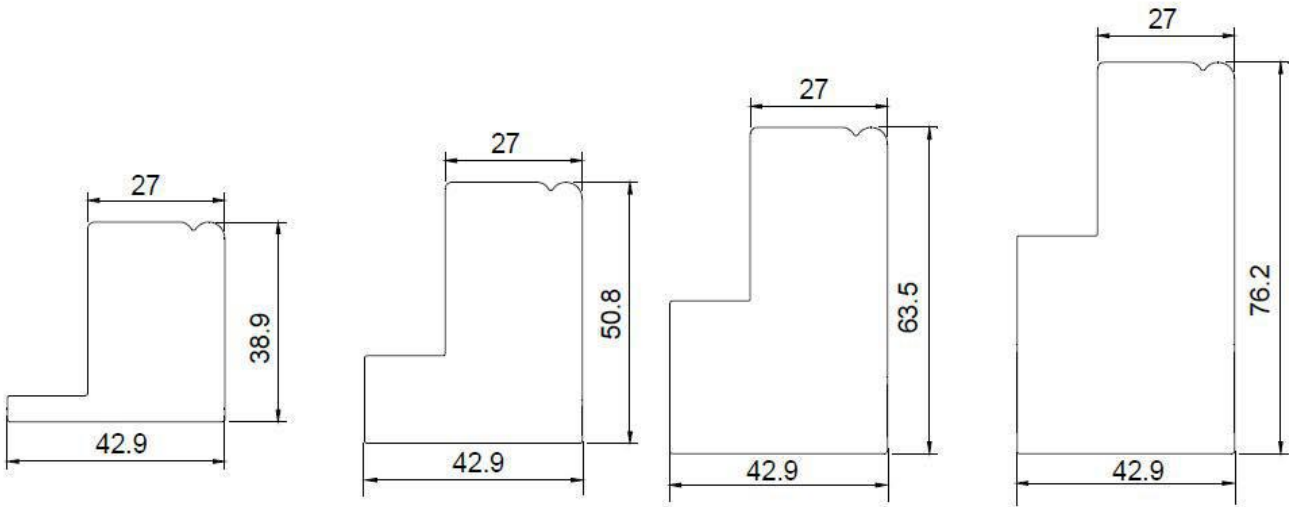

39mm

50mm

63mm

76mm

INSERT L FRAME

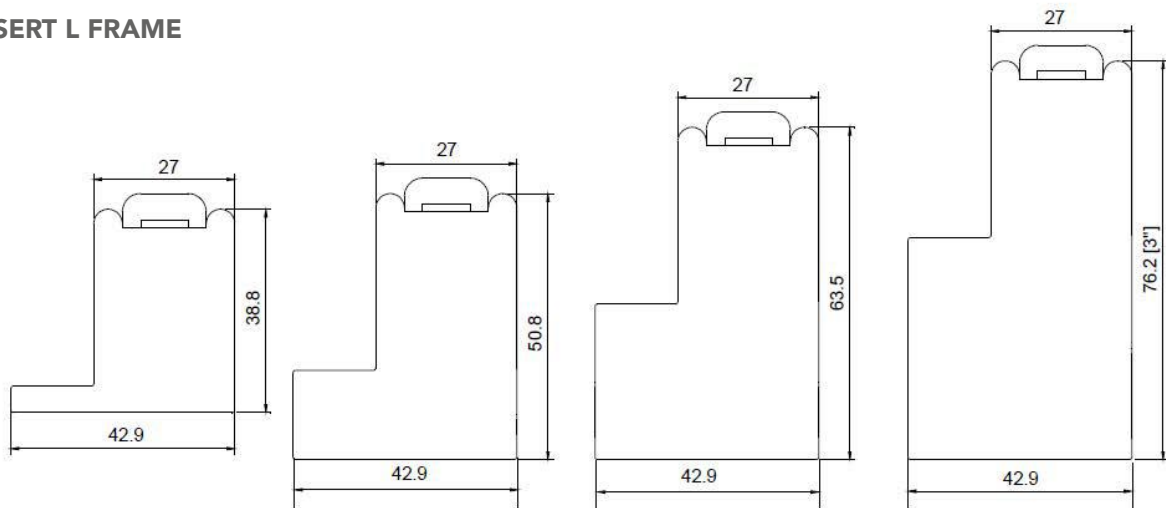

39mm

50mm

63mm

76mm

CROWN Z FRAME

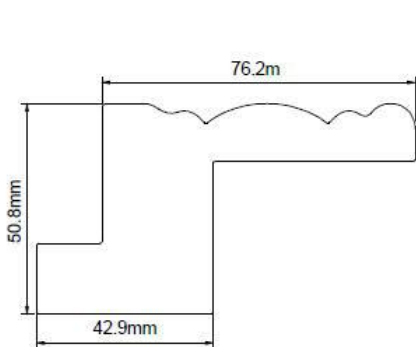

76mm

DEEP BULLNOSE Z FRAME

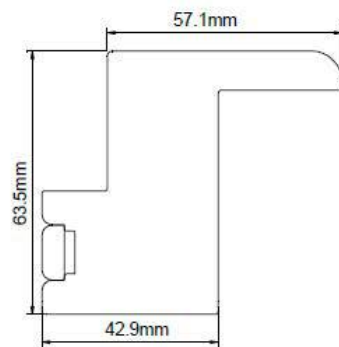

57mm

BULLNOSE Z FRAME

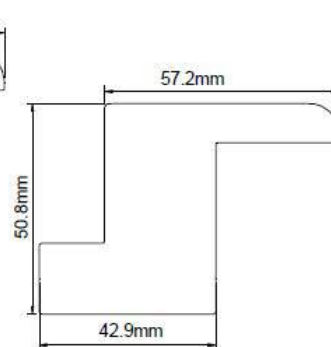

57mm

DEEP PLAIN L FRAME/ DEEP BULLNOSE Z SILL PLATE

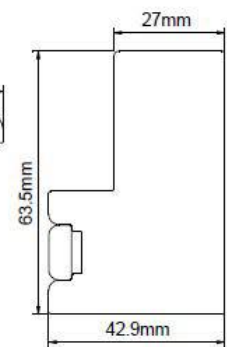

63mm

TIARA Z FRAME

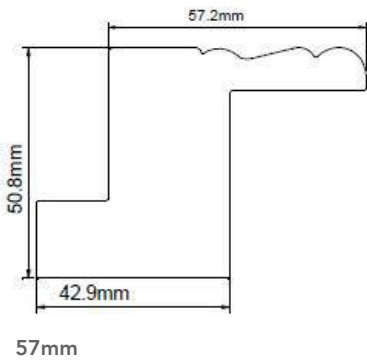

SERRATE Z FRAME

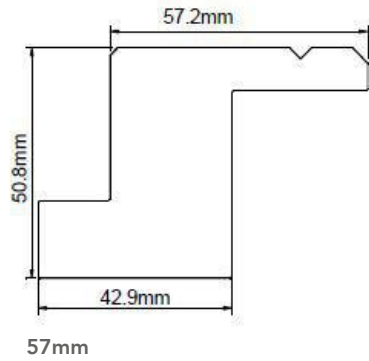

**PLAIN L FRAME/
SERRATE Z SILL PLATE** **BEADED Z FRAME**

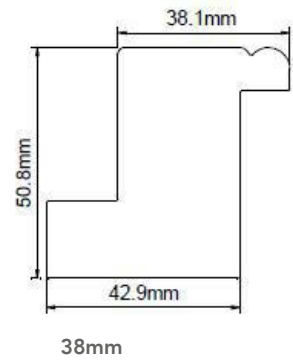
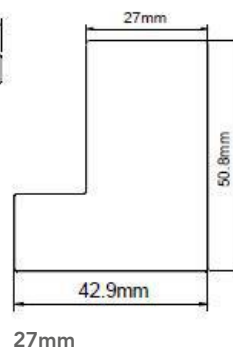

CAMBER DECO FRAME

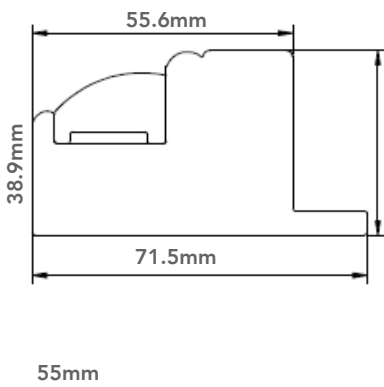

RIDGE DECO FRAME

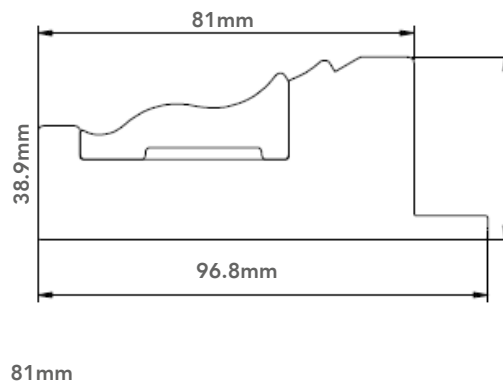

MISSION FRAME

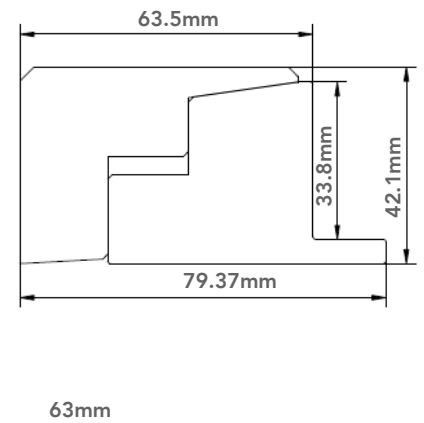

HANG STRIP WITH INSERT

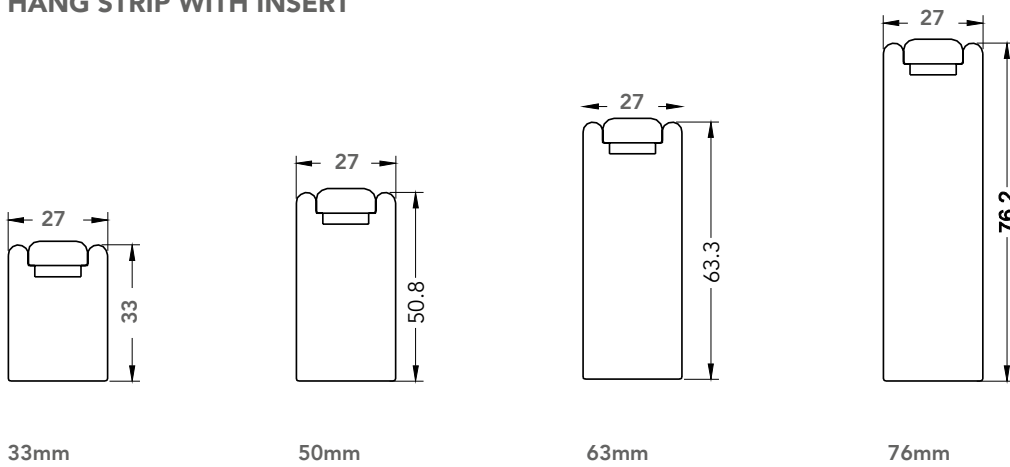

NB. Hang strip is only available for beside the panel, not available for behind the panel.

BAY POSTS

Additional custom angles are also available. Custom angle bay posts cannot have the insert strip.

135° angle

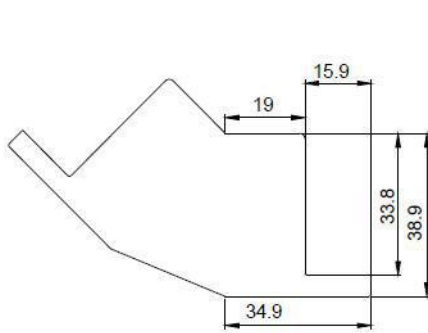

(Deco Frame)
 38mm

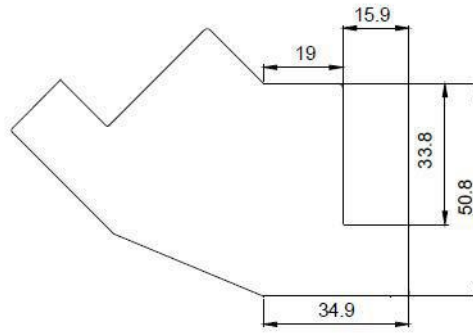

(L/Z/HS Frame)
 50mm

CORNER POST

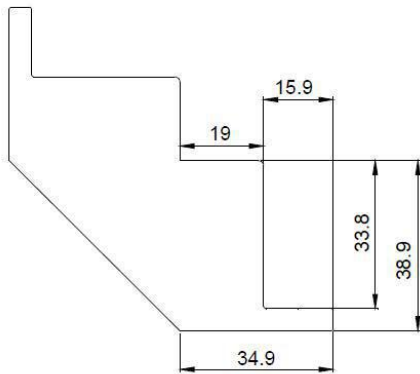

(Deco Frame)
 38mm

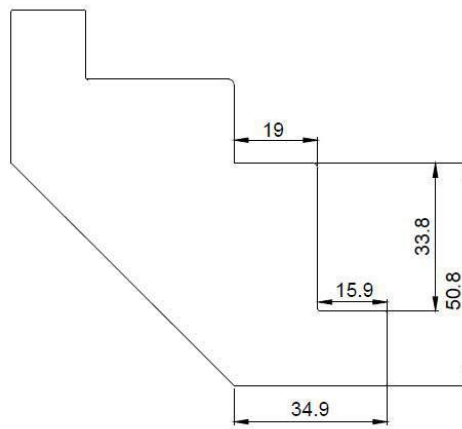

(L/Z/HS Frame)
 50mm

**T POST
 DECO FRAME**

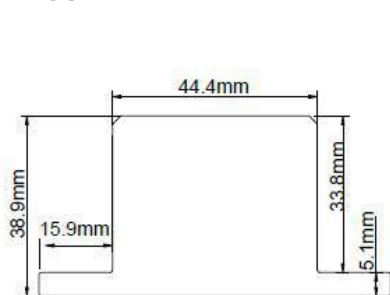

T POST (L/Z/HS)

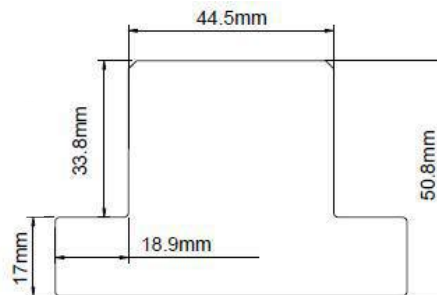

NB. Please note that horizontal T Posts over 1219mm are not covered by warranty.

COVER STRIP

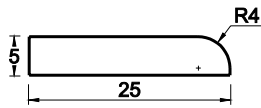

25mm

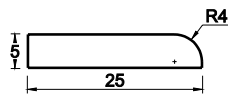

15mm

* Cover strips are made in wood.

LIGHT BLOCK*

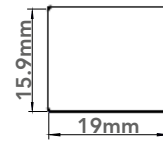

BATTENS

Battens can be butt-jointed as per the drawings below:



Standard sizes:

Stock Battens are available in the following sizes:

Made of Wood

- 2.5mm x 27mm
- 3mm x 15mm
- 3mm x 20mm
- 3mm x 30mm
- 3mm x 60mm
- 5mm x 45mm
- 5mm x 63.5mm
- 30mm x 40mm
- 40mm x 40mm
- 25mm x 30mm
- 25mm x 40mm

Special shape battens are available

Battens and Panels identification: The PLANTATION SHUTTERS order number will be stamped on the bottom of each panel and one end of each corresponding batten to identify which one belongs to which item.

For batten width less than or equal to 3mm, there will be no warranty if the batten depth is over 100mm, for batten width over 3mm, there will be no warranty if the batten depth is over 200mm.

BUILD-OUT (EXTENSION)

1. For L/Z/Deco/Hang Strip Frame including T-Post, we will pre-attach the build-out of which the thickness is less than 50.8mm (including 50.8mm) by default;
2. For L/Z/Deco/Hang Strip Frame including T-Post, when build-out is over 50.8mm, we will supply build-out loose with holes pre-drilled; also note that for frame not able to pre-drill holes, such as Beaded L Frame, we will supply build-out loose without holes pre-drilled, either.
3. For all frames, we will add build-out per the order form. E.g., if the frame type is 76mm L Frame, and build-out is 10mm, we will use 76mm L Frame added with 10mm build-out instead of changing the frame type to 50mm L Frame added with 36mm build-out.
4. Extension for Z Frame: If you want the timber to be added to bottom of Z frame like the drawing on the right, please ALWAYS specify in the line notes on your order form, "Add extension to light block section". The DEFAULT EXTENSION will be the left drawing.
5. For Bay/ Corner Post, we will supply a build out in every case pre-attached as default.

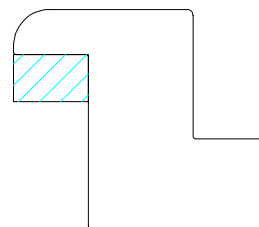

Default

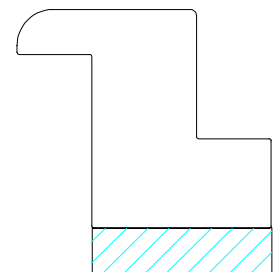

Optional

4. PANEL DETAILS

STILE

Chamfer 50.8mm/ 57.15mm Butt Stile: Usually used on the side of the panel that is hinged to the batten or frame.

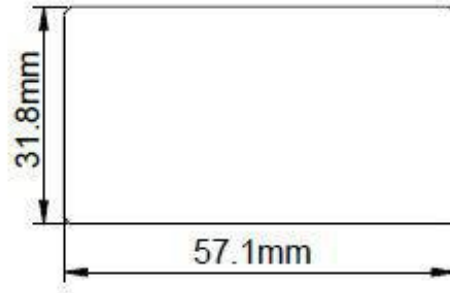
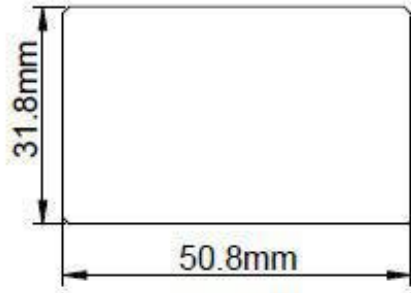

Chamfer 50.8mm/ 57.15mm Rebate Stile: Used on bi-fold panels or where two panels meet

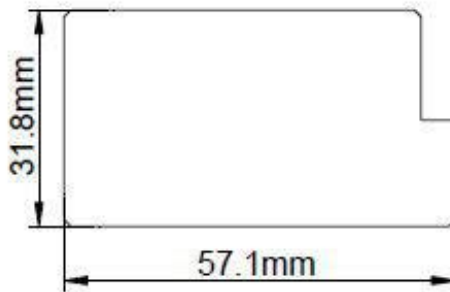
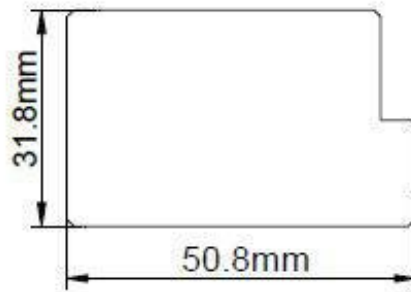

RAILS

The factory will decide the size, unless otherwise specified in the notes section on the order. The top and bottom rail will be the same size if there is no divider rail. If you need different size rails, please specify.

We suggest ordering shutters for the same customer at the same time, so that the rail sizes will match.

Please note the standard top/bottom rail sizes should be within 69.85mm~165.1mm.

For regular shutters, the step for the rail size is 3.175mm.

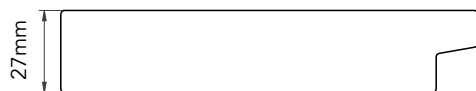

STANDARD MID-RAILS

The standard Mid-Rail size is 76.2mm high. Different mid-rail sizes can be requested though the combination of a fixed overall panel drop and louvre sizes means that it may not always be technically possible to fulfil every custom rail request.

If the panel height is greater than 2133mm one or more mid-rails are required. If the height from the centre of the mid-rail to the top of the top rail or bottom of the bottom rail is 2133mm or more, then another mid-rail is required. Mid-rail positions should be specified at time of ordering. If the order specifies that a mid-rail is not required then all warranties on the order are automatically waived.

PLEASE NOTE: Normally, the maximum size a mid-rail can be made is 165.1mm, anything over 76.2mm will carry a surcharge.

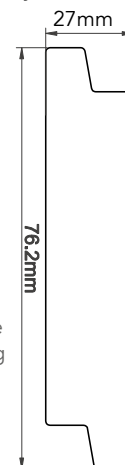

MID-RAIL continued

Specified rail position is taken from the base of the shutter set to the centre point of the rail, except for solid based which is from the bottom to the top of the mid-rail.

The centre rail can deviate by + or - by the amount of millimetres shown below. If the mid-rail is to be exact with no deviation then you must tick the exact box on Gateway.

Louvre Size	Allowable +/- Deviation
47mm	19mm
63mm	25mm
76mm	31mm
89mm	38mm
114mm	51mm

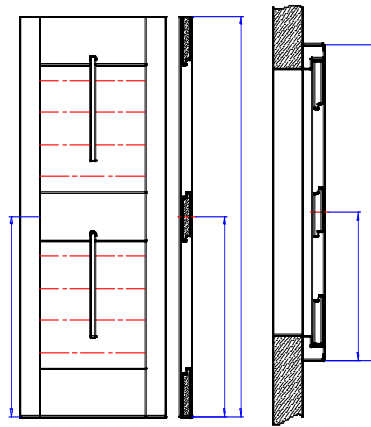

LOUVRES

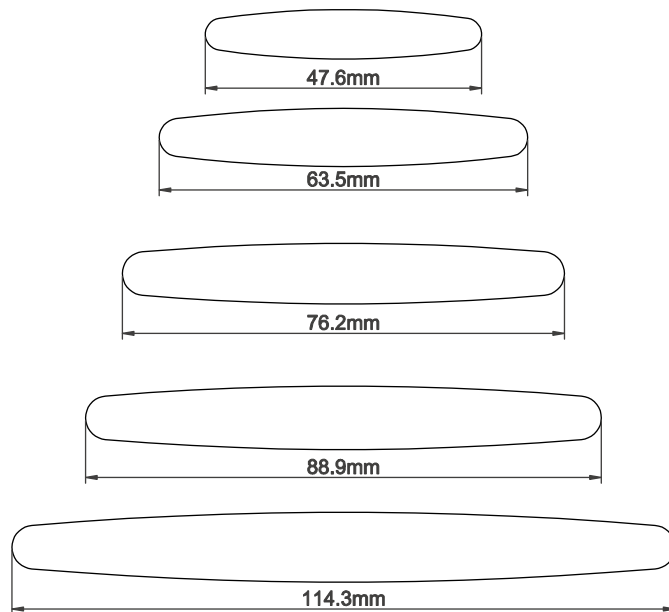

LOUVRE PIN

Louvre pins are used to ensure louvre tension. In addition a tension screw is inserted into one louvre in the panel. This is the same for all louvre sizes. Access holes are drilled in the stile for each panel to allow the tightening or loosening of the tension screw, to adjust the louvre tension. Please note therefore additional holes will be visible in the stiles.

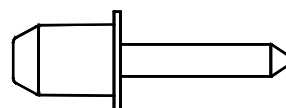

TILT RODS

Standard tilt rod

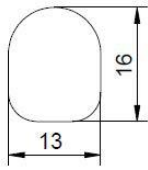

Louvre Size	Max Possible Louvres	Panel Height Range
63mm	24	1289 - 1385mm
76mm	19	1276 - 1372mm
89mm	16	1289 - 1385mm
114mm	12	1289 - 1385mm

Silent tilt rod

Silent Tilt rods are integrated into the stile and are not visible. Silent tilt rods are available in 63mm, 76mm, 89mm and 114mm louvres. The 47mm does not have this option.

The Silent Tilt rod will automatically be split into 2 parts when the number of louvres connected to the silent tilt rod exceeds the following limit.

If the louvre quantity exceeds the above limit, the gear tilt control will be equally split into halves. If the louvre quantity is odd the bottom section will have one more louvres than the top section. If the panel has a divider rail, and the louvre quantity above divider rail or below divider rail exceeds the above limit, split tilt rods are also required.

SPECIFIED SPLIT TILT LOCATION*

Measure from the bottom of bottom frame to the top of the louvre if order OD of frame, and from the bottom of the panel to the top of the louvre if order net panel size or overall panel size. Please note that the louvres are in close position when measured.

Louvre Size	Allowable +/- Deviation
47mm	19mm
63mm	25mm
76mm	31mm
89mm	38mm
114mm	51mm

*Please note this is recommended for silent tilt only not centre or offset tilts.

OFFSET TILT RODS

Offset tilt rods can be ordered. The standard offset is 25mm from the centre of the tilt rod to the end of louvre on hinge side. If a different offset is required please specify the position from the centre of the tilt rod to the end of the louvre on the hinge side in the short notes on the order form.

The centre of the tilt rod will be 25mm from louvre end on hinge side of the panel. For Fixed panels, the offset tilt rods will be positioned on the left side for all panels. For special shaped panels, the offset tilt rods will be on the higher side of the stile.

OFFSET TILT ROD FOR MULTI-FOLD SHUTTERS

Multi-fold panels will be made with the tilt rod offset from the centre to enable panels to be folded flat without tilt rods obstructing one another. The standard offset for the tilt rod is 7mm from the centre, i.e. tilt rod will be 7mm to the left of centre for left panels, and 7mm to the right of centre for right panels. Rebates between panels are made right over left. Bi-Fold panels (LR or LLRR) do not require offset tilt rods.

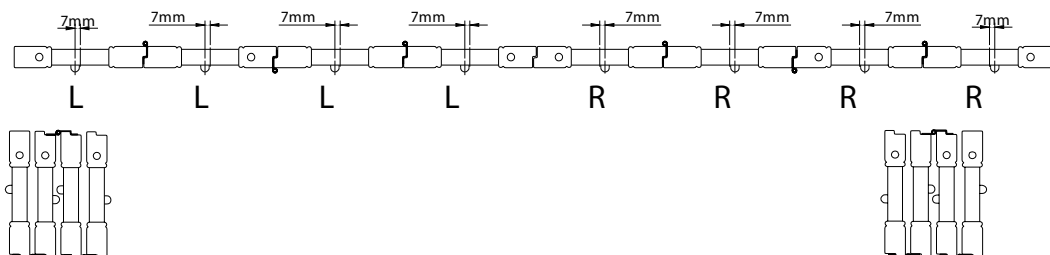

SOLID PANELS

[BACK TO TOP](#)

Available in

- Raised panel with louver combination
- Raised panel only.

Specifications

- 304.8mm(12") < raised panel section height < 1219.2mm(48").
- Divider rail is required for panel heights over 2133.6mm(84").
- The maximum panel height is 3657mm (144").

Raised Panel Location(s)

- Top
- Middle
- Bottom
- All (if panel height does not exceed 1219.2mm(48").

Rails

- For a panel with raised panel section only, 76.2mm(3") is the standard size for top, bottom and divider rails.
- The minimum size for top and bottom rails is 76.2mm(3").
- If you are matching raised panels to standard shutter panels, the top rail of the standard shutter panel will match the top rail of the raised panel. Please specify clearly when placing order.

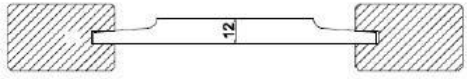
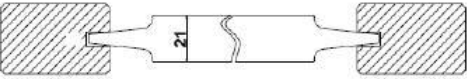
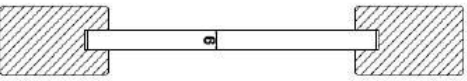
Name	Drawings	Code#	Description
Solid Raised		SR	12mm infill (timber)
Double Raised		DB	21mm infill (timber)
Solid Shaker		SS	Paint: 9mm infill (MDF) Stain: 9mm infill (Timber)

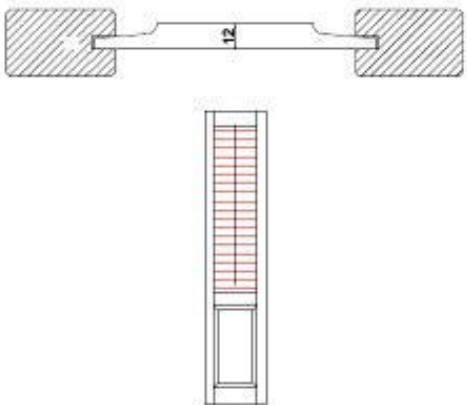
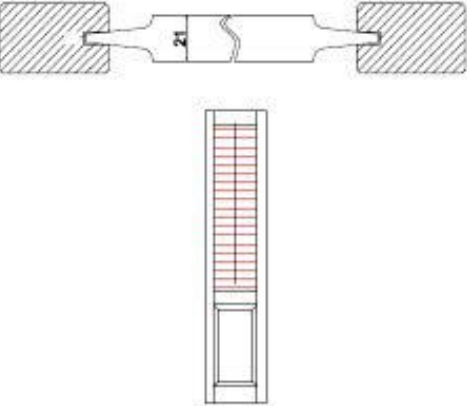
Solid Base		SB	Base is solid raise only; solid shaker is not available for this option.
Solid Base Double		SBD	Base is solid raise only; solid shaker is not available for this option.

6. HARDWARE

[BACK TO TOP](#)

Standard Hinges:

Rebate or Self-Mortice hinges are provided depending on the configuration. They are pre-mounted on panels and frames by two screws in the slotted holes. The screw for the third rest hole should be installed at installation. The hinge pins are removable.

Standard Hinge Colours

Antique Brass, Bright Brass, Black, Nickel Plated, Stainless Steel (Surcharge), Brushed Nickel Plated (Surcharge), White, Pearl, Bisque, Pure White, Crisp Linen, String, Sea Mist, Stone Grey, Brown Grey, Taupe Grey.

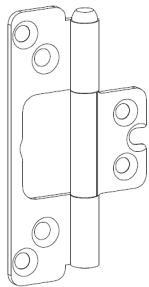

Please Note: End of hinge to top/bottom of panel is 50.8mm.

For the Ultrawood program

Panel height	No. of hinges
<=1219mm	2
1219mm~1981mm	3
1981mm~2438mm	4
2438mm~3048mm	5
>3048mm	6

Adjustable hidden hinge (optional upgrade):

Adjustable hidden hinge: silver, black, champagne:
Use between panel and frame or t-post.

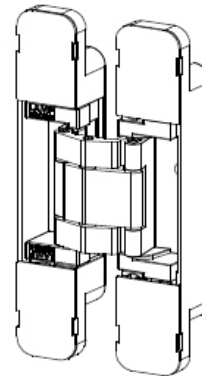

*Please note, panel to panel will be standard hinges

Adjustable Hidden Hinge for the Samoa program

Panel height	No. of hinges
<=1981.2mm	2
1981.2mm<H<=2794mm	3
H>2794mm	4

MAGNETS

Round magnets are pre-mounted on the panels and the catch is pre-mounted on the frame when the order is 'OD' type. An 'L' shaped magnet catch is included in the hardware box when ordering 'OP' type.



CATCHPLATE



MAGNET

HANDLE OPTIONS

Handle A and B are available to order in Nickel Plated only. Please specify the handle you require along with the quantity on the notes section of your order card, they will not be pre installed but supplied loose in the hardware box. (Surcharge will apply).



Handle A

Handle B

PANEL FEET

Panel feet are mounted on the bottom of panels when ordering 'OD' type.

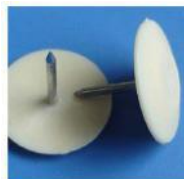

L SHAPE MAGNET CATCH

When ordering 3 sides frames with the gap more than 2.5mm, we will supply L shape magnet catch.



HOFFMAN KEYS

These are supplied and are used to join frame corners together.



HINGE SPACER

To make installing shutters an easier experience, a hinge spacer will be included. It is common to find windows that are built square, and depending on its evenness of the mounting surface and how the shutters are installed, the outcome of the installation might be different. The hinge spacer is an easy and reliable tool to help installers overcome such variations during the installation process.

SIDE MAGNETS

This option is available in the order card and when selected will add a magnet situated in the side of stile (1). It can be selected where a Left and Right panel meet where there is no lightblock or bottom frame to secure the panels. The magnets will act to keep the panels together (2). Please note that the side magnet is not available if a rebate stile has been selected.



(1) Magnet shown in side of stile



(2) Magnet keeping panels together

The side magnet can be selected where you have:

- a) Door shutters that require bottom clearance.
- b) Tier on Tier shutters without horizontal T post.
The side magnet will be installed on the top of the bottom tier and the bottom of the top tier (3).
- c) Café style shutters with upside down goal post frame (4).
- d) Window that do not have a light block or bottom frame (5).

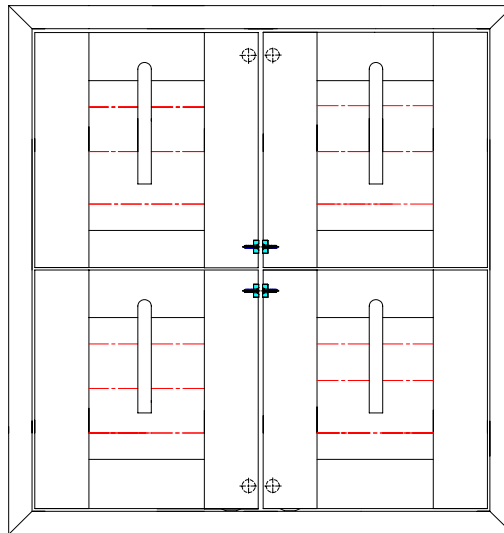

(3) Double Hung shutter without horizontal T post

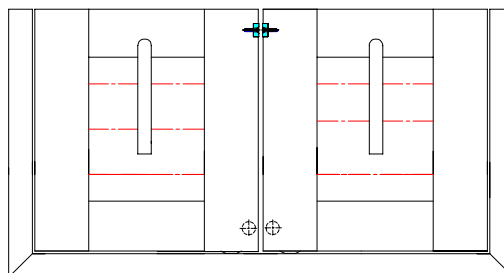

(4) Café Shutter

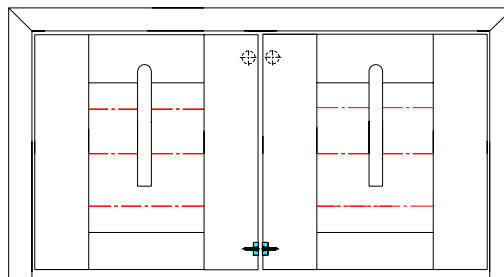

(5) No frame or light block on either top or bottom

BOLT & RING PULL



1. Barrel Bolt

Can be used for hinged shutter and Bi-fold track shutter to fit for panels.



2. Ring Pull

Can be used for hinged shutter and track shutter. The location of the ring pull, refer to the bolt location.

RING PULL & BARREL BOLT

LL

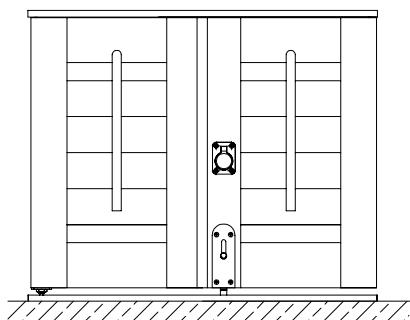

RR

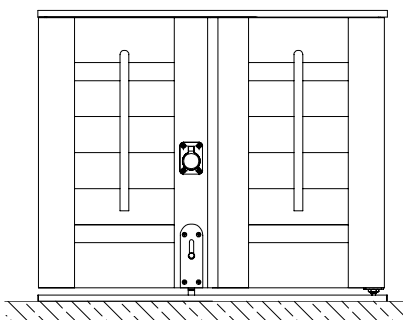

LLL

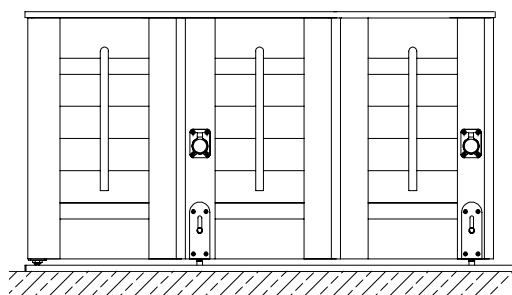

RRR

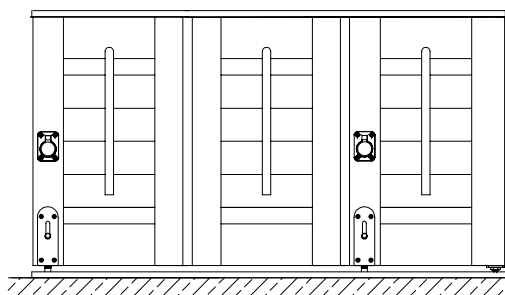

LLRR

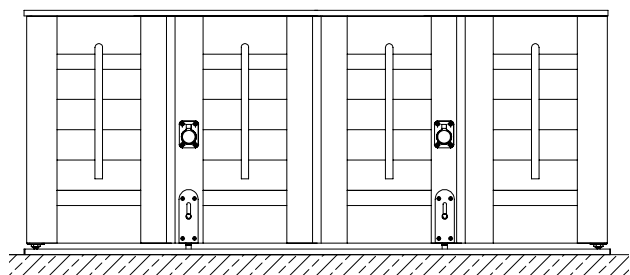

LLLR

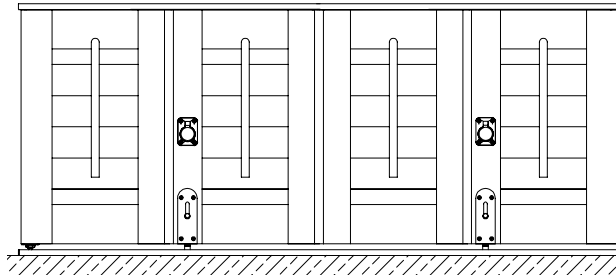

RING PULL & BARREL BOLT Cont.

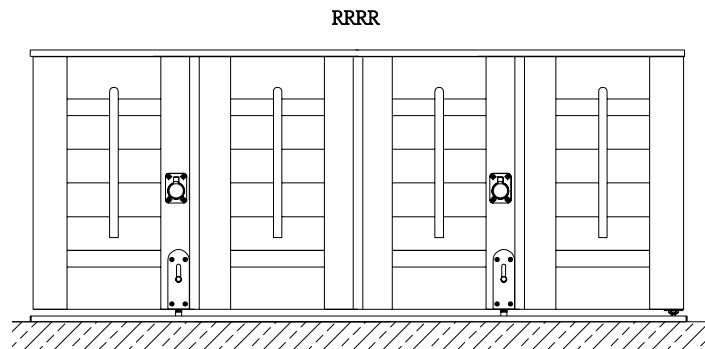

The bolt location for both track system shutters and regular shutters would be the same. The general principle is that the bolt position will avoid the stile which will install the spring-loaded guide at bottom (same stile as the Wheel carrier).

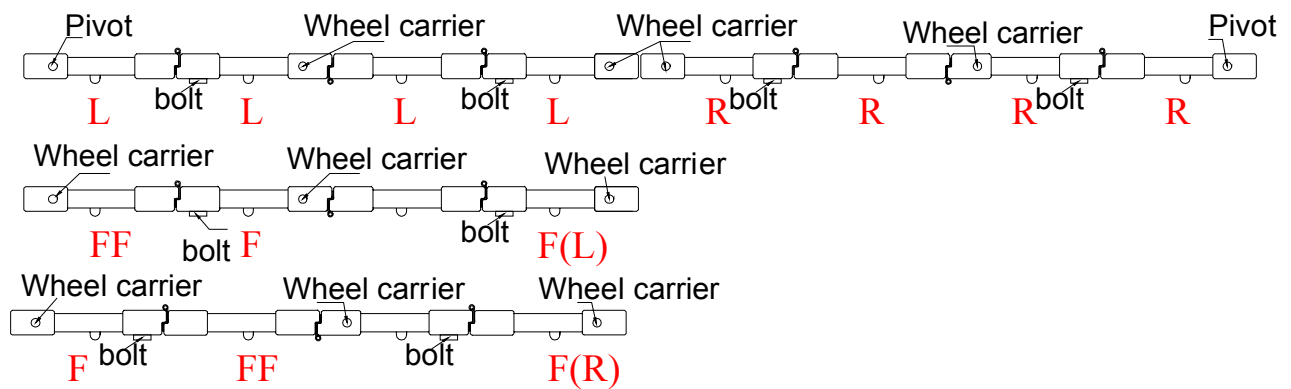

Ring Pull and Barrel Bolt: Customer needs to specify ring pull location on the order form. Ring pull location principle for Floating Panels: (same as the location of 90° Bifold Track)

1. When floating panel config is in pairs, it will be split into halves, the left will be for LL and the right will be for RR. So the ring pull location for FF/FF, FF/FF/FF/FF will be same as that of panel config as LL/RR, LL/LL/RR/RR.
2. When floating panel config is FF, the ring pull location will be same as that of panel config LL.
3. When floating panel config is singular, it will be split into 3 sections, the left and mid sections are for LL and the right section is for RR. So the ring pull location for FF/FF/FF, FF/FF/FF/FF/FF will be same as that of LL/LL/RR, LL/LL/LL/RR/RR.

Please note the ring pull finish will match with the hinge finish.

Please see the matching chart below:

Hinge	Pure White	Silk White	Bisque	Pearl	Black	Nickel	Brushed Nickel	Antique Brass	Bright Brass	Stainless Steel
Ring Pull	White	White	Bisque	Pearl	Black	Brushed Nickel	Brushed Nickel	Antique Brass	Bright Brass	Brushed Nickel

Position: For different panel configuration, please refer to the location of bolt to show on which stile the pull will be fixed.

Hinge	Crisp Linen	String	Sea Mist	Stone Grey	Brown Grey	Taupe Grey
Ring Pull	Bisque	Bisque	Brushed Nickel	Brushed Nickel	Brushed Nickel	Brushed Nickel

NOTE

1. If bolt is requested on track system shutters, the bolt will be installed as per the above drawings.
2. The general principle is that the bolt position will not be on the panel, which has the spring-loaded guide at the bottom. That is to say, it will be on the right stile of the 1, 3, 5...odd number panels for L panel fold. It will be on the left side of 2, 4, 6...even number panels for R panel fold. (always count from left to right) see the fold below as example:

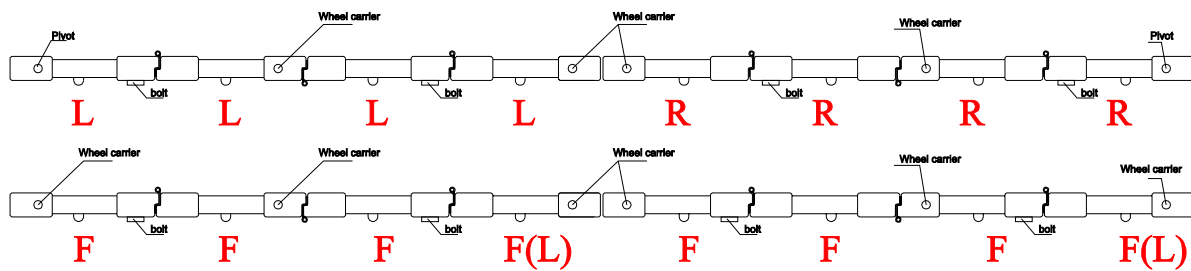

3. If both ring pull and bolt are required on the track system shutters, then, the ring will be on the same stile as bolt. When there is no mid rail, ring pull will be just on top of the bolt (70mm above bolt) as default location; if there is a mid rail, bottom of ring pull will line up with top of mid rail as default location.

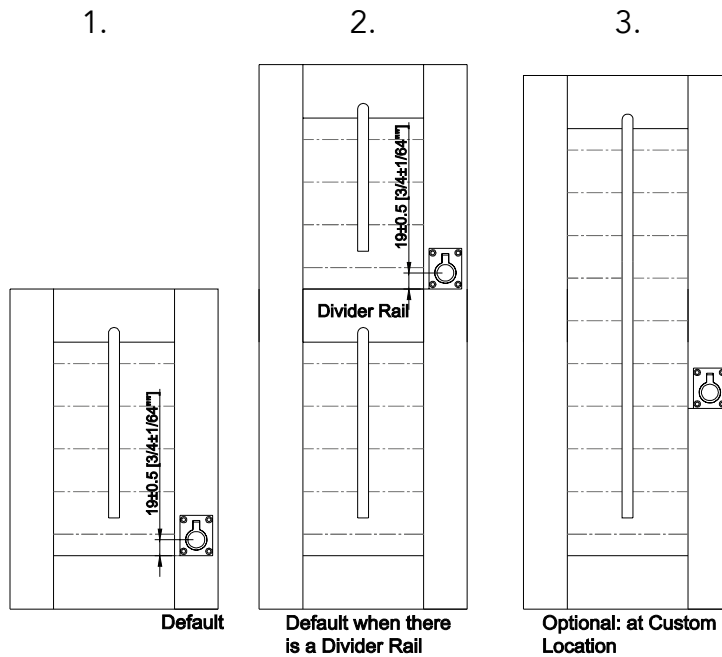

Position:

1. Above Bottom Rail (Default)
2. Above 1st Divider Rail (Default when there are Divider Rails)
3. Custom Location

If both bolt & ring pull are specified, the distance between them is 2 3/4" (70mm), and the ring pull location is 6 3/4" (170mm) from the bottom of panel.

When there is no mid rail, ring pull will be just on the top of Bolt (2 3/4" /70mm above bolt) as default location; if there are mid rails, bottom of ring pull lines up with top of the 1st mid rail as default location.

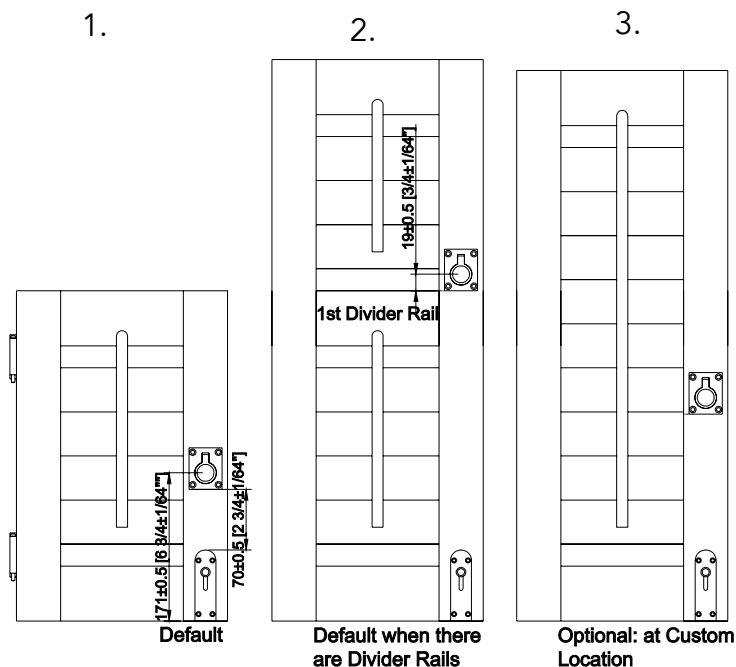

Position:

1. 2 3/4" (70mm) Above bolt (Default when both Ring Pull and bolt are specified)
2. Above 1st Divider Rail (Default when there are Divider Rails)
3. Custom Location

Measurements:

Window size: Measure from the bottom of the window to the centre of the ring pull

Max frame-to-frame: Measure from the bottom of the frame to the centre of the ring pull

Shutter used for door without bottom support:

In situations where shutters are used for door applications, which do not have any support underneath the panels, the customers must inform PLANTATION SHUTTERS when placing this type of order. (See the following specs for Shutters used in Door applications)

Please note:

- (1) The factory will add extra hinges (but not hidden hinge) to support the panels.
- (2) Bigger and Stronger Top and Bottom rails will be added to reduce the probability of the panels sagging and increase shutter intensity.
- (3) If customers fail to notify PLANTATION SHUTTERS that the shutter will be used in door applications, the customers will be responsible for the cost of the any re-order that is submitted.

Please see the following chart for details.

Panel Configuration	
L,R,LR	LL, RR, LLRR
Manufactured with warranty	Must order it with track

PANEL WEIGHT

Panel Weight		
Material	Louvre size	Weight (kg)/m ²
Ultrawood	47mm	TBC
	63mm	TBC
	76mm	TBC
	88.9 mm	TBC
	114.3 mm	TBC

* Average Weight

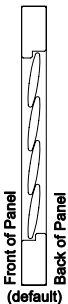
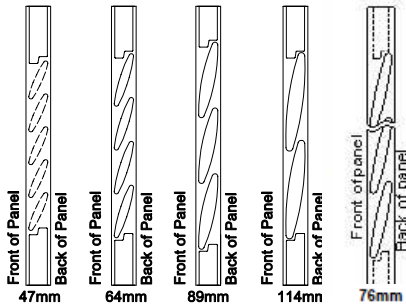
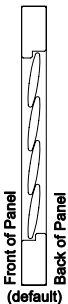
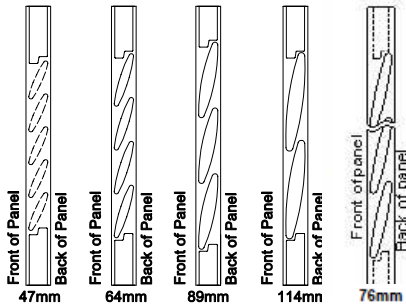
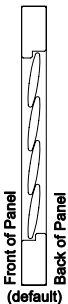
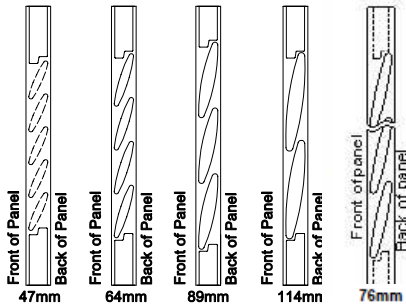
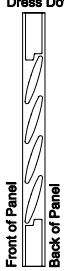
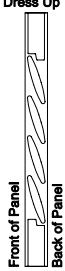
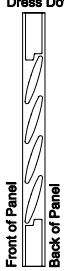
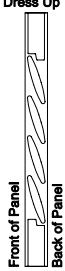
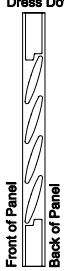
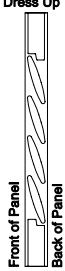
FIXED LOUVRE OPTIONS					
<p>Available in two positions: closed or open at angle.</p>	<table border="1"> <thead> <tr> <th>Fixed Closed Position</th> <th>Fixed Open Position</th> </tr> </thead> <tbody> <tr> <td style="text-align: center;">  <p>Front of Panel Back of Panel (default)</p> </td> <td style="text-align: center;">  <p>Front of Panel Back of Panel 47mm 64mm 89mm 114mm 76mm</p> </td> </tr> </tbody> </table>	Fixed Closed Position	Fixed Open Position	 <p>Front of Panel Back of Panel (default)</p>	 <p>Front of Panel Back of Panel 47mm 64mm 89mm 114mm 76mm</p>
	Fixed Closed Position	Fixed Open Position			
 <p>Front of Panel Back of Panel (default)</p>	 <p>Front of Panel Back of Panel 47mm 64mm 89mm 114mm 76mm</p>				
<p>The standard default orientation for Fixed louvres is Closed 'Dress Down' with the bottom edge of louvres to the front of the panel. 'Dress Up' option is also available if specified on the order form.</p> <p>NB. Note that normal orientation for <i>adjustable louvres</i> when closed is in the 'Dress Up' state.</p>	<table border="1"> <thead> <tr> <th>Dress Down</th> <th>Dress Up</th> </tr> </thead> <tbody> <tr> <td style="text-align: center;">  <p>Front of Panel Back of Panel</p> </td> <td style="text-align: center;">  <p>Front of Panel Back of Panel</p> </td> </tr> </tbody> </table>	Dress Down	Dress Up	 <p>Front of Panel Back of Panel</p>	 <p>Front of Panel Back of Panel</p>
Dress Down	Dress Up				
 <p>Front of Panel Back of Panel</p>	 <p>Front of Panel Back of Panel</p>				

SPECIAL SHAPE SHUTTER OPTIONS

BACK TO TOP

FAN TOP

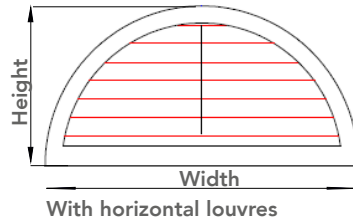
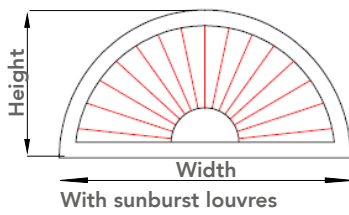

FAN TOP

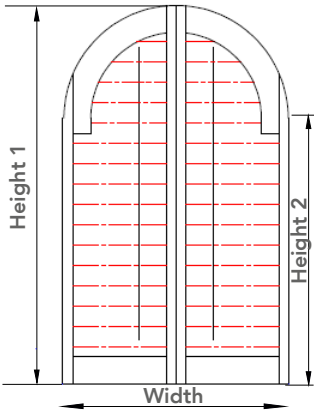

TAPERED

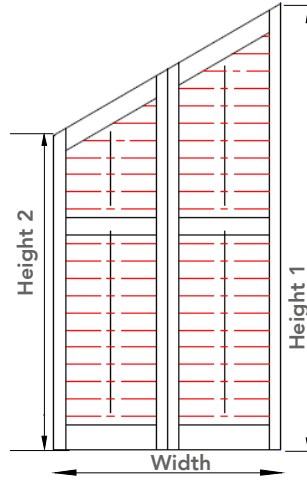

CIRCLE

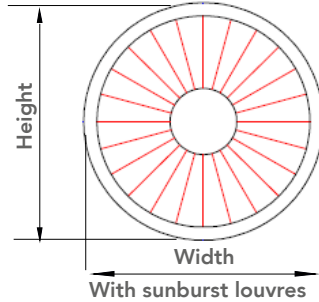
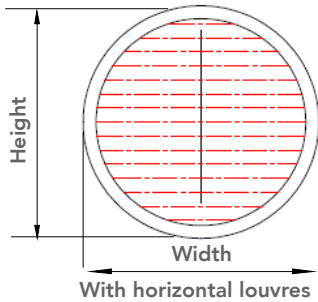

OCTAGON

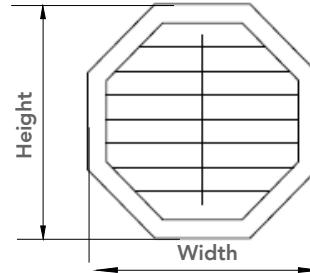

HEXAGON

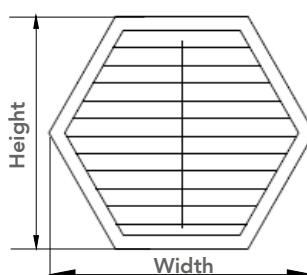
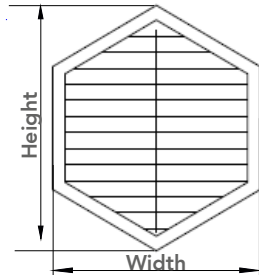

Templates

Inside recess fitting

A template is always required.

Outside recess fitting

1. For a perfect arch, template is not required.
2. If the shutter is an imperfect arch or any other shape, a template is required.

All templates should show the OD dimension of the shape required and state clearly which surface is the front.

For special shape shutters, PLANTATION SHUTTERS will produce a CAD drawing for distributor approval. Please check every dimension shown on the drawing to prevent any mistake or misunderstanding.

The distributor should approve and return this to PLANTATION SHUTTERS for production to commence.

NB.

- All special orders are on extended lead times and require an additional one week for manufacturing from approval of the drawings.
- Frames with insert strips will not have removable strips around curves.
- For angled or arched shutters the leg height must be more than 60% of the overall height to maintain warranty for the panels hinged to the leg frame.

7. SIZING AND MEASURING

ORDER SIZE DEFINITION

Overall Panel size (OP):

The size given is the overall panel size. The width does not include the hinge space from panel to batten on the left & right side, but does include the gap between panels, the standard gap is 2mm between panels and we will calculate the single panel width based on this measurement (see diagram below). The height given must be net panel height. We will pre-mount the hinges and the magnets and include panel feet and L shape magnet catches in a hardware box. The stile can be Rebate or Butt, please specify in the relevant section of the order form.

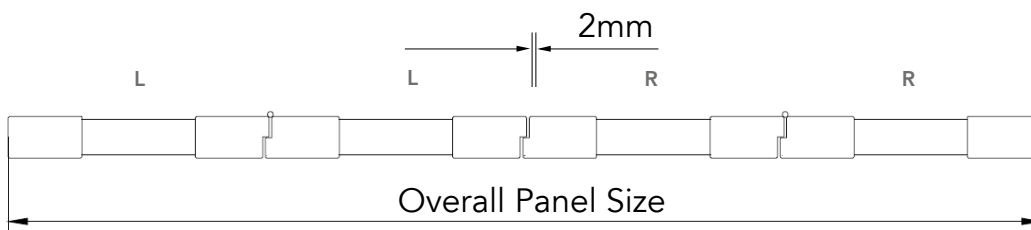

OD of frame:

Size given is "Outside Dimension" of the shutter; we will pre-mount the hinges and the magnets, and will include all the necessary hardware in a hardware box. The stiles can be Rebate and D-Mould stile, please specify on the order form.

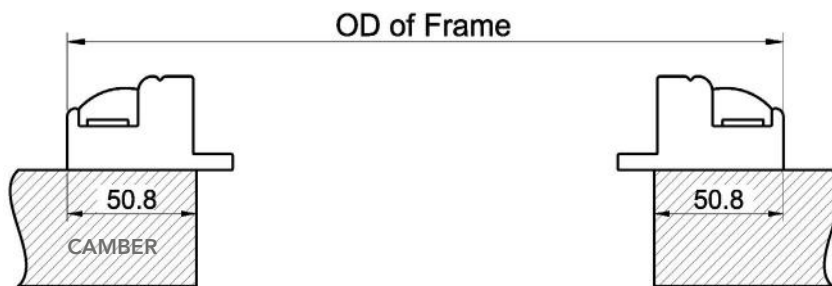

Camber Deco Frame 50mm: Can only be ordered as outside mount, the size given must be OD of frame size.



"Z" frame: Can only be ordered as inside mount, the size given must be OD of frame size. (Backside of Z frame, refer the drawings).

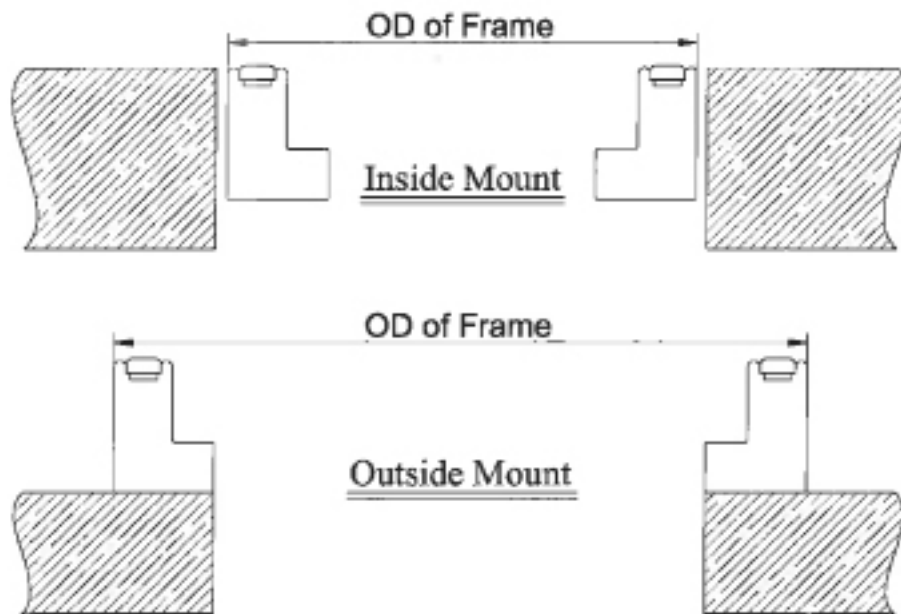

"L" frame: Can be ordered as inside mount and outside mount, size given must be OD of frame size.

TOLERANCES

Width: The width of the panel can be plus or minus 1.6mm from the order width.

Height: The height of the panels can be plus or minus 1.6mm from the order height.

Mid Rail location: Mid Rail location may be off by half a louvre space. Measure from bottom of bottom frame to centre of Mid Rail if order OD of frame, and from bottom of panel to centre of Mid Rail if order net panel size or overall panel size.

For 47mm louvre can be off by +/-19mm.

For 63mm louvre can be off by +/-25mm.

For 76mm louvre can be off by +/-31mm.

For 89mm louvre can be off by +/-38mm.

For 114mm louvre can be off by +/-51mm.

MOUNTING TYPE

Café style shutter: Please specify on the order form if the shutter is a café style. We will finish the top of the panels and one end of the battens.

If a café shutter is required with a 3 sided frame, it should be 3 sides inverted.

Tier on Tier: The standard gap between the top tier and bottom tier is 2.5mm.

Full height: Regular shutters running the full height of a window.

Plantation Shutters Ltd
Unit 10 River Reach Business Park
1 Gartons Way
Battersea
London
SW11 3SX
Tel: 020 8871 9222

www.plantation-shutters.co.uk

Emma - Sales Manager
emma@plantation-shutters.co.uk